

# *SunISDN™ 1.0.4 User's Guide*



THE NETWORK IS THE COMPUTER®

**Sun Microsystems Computer Company**

A Sun Microsystems, Inc. Business  
2550 Garcia Avenue  
Mountain View, CA 94043 USA  
415 960-1300 fax 415 969-9131

Part No.: 802-6280-11  
Revision A, January 1997

Copyright 1997 Sun Microsystems, Inc. 2550 Garcia Avenue, Mountain View, California 94043-1100 U.S.A. All rights reserved.

This product or document is protected by copyright and distributed under licenses restricting its use, copying, distribution, and decompilation. No part of this product or document may be reproduced in any form by any means without prior written authorization of Sun and its licensors, if any.

Portions of this product may be derived from the UNIX<sup>®</sup> system, licensed from Novell, Inc., and from the Berkeley 4.3 BSD system, licensed from the University of California. UNIX is a registered trademark in the United States and in other countries and is exclusively licensed by X/Open Company Ltd. Third-party software, including font technology in this product, is protected by copyright and licensed from Sun's suppliers.

**RESTRICTED RIGHTS:** Use, duplication, or disclosure by the U.S. Government is subject to restrictions of FAR 52.227-14(g)(2)(6/87) and FAR 52.227-19(6/87), or DFAR 252.227-7015(b)(6/95) and DFAR 227.7202-3(a).

Sun, Sun Microsystems, the Sun logo, and Solaris are trademarks or registered trademarks of Sun Microsystems, Inc. in the United States and in other countries. All SPARC trademarks are used under license and are trademarks or registered trademarks of SPARC International, Inc. in the United States and in other countries. Products bearing SPARC trademarks are based upon an architecture developed by Sun Microsystems, Inc.

The OPEN LOOK<sup>®</sup> and Sun<sup>™</sup> Graphical User Interfaces were developed by Sun Microsystems, Inc. for its users and licensees. Sun acknowledges the pioneering efforts of Xerox Corporation in researching and developing the concept of visual or graphical user interfaces for the computer industry. Sun holds a nonexclusive license from Xerox to the Xerox Graphical User Interface, which license also covers Sun's licensees who implement OPEN LOOK GUIs and otherwise comply with Sun's written license agreements.

THIS PUBLICATION IS PROVIDED "AS IS" WITHOUT WARRANTY OF ANY KIND, EITHER EXPRESS OR IMPLIED, INCLUDING, BUT NOT LIMITED TO, THE IMPLIED WARRANTIES OF MERCHANTABILITY, FITNESS FOR A PARTICULAR PURPOSE, OR NON-INFRINGEMENT.

---

Copyright 1997 Sun Microsystems, Inc., 2550 Garcia Avenue, Mountain View, Californie 94043-1100 U.S.A. Tous droits réservés.

Ce produit ou document est protégé par un copyright et distribué avec des licences qui en restreignent l'utilisation, la copie et la décompilation. Aucune partie de ce produit ou de sa documentation associée ne peut être reproduite sous aucune forme, par quelque moyen que ce soit, sans l'autorisation préalable et écrite de Sun et de ses bailleurs de licence, s'il y en a.

Des parties de ce produit pourront être dérivées du système UNIX<sup>®</sup> licencié par Novell, Inc. et du système Berkeley 4.3 BSD licencié par l'Université de Californie. UNIX est une marque enregistrée aux Etats-Unis et dans d'autres pays, et licenciée exclusivement par X/Open Company Ltd. Le logiciel détenu par des tiers, et qui comprend la technologie relative aux polices de caractères, est protégé par un copyright et licencié par des fournisseurs de Sun.

Sun, Sun Microsystems, le logo Sun, et Solaris sont des marques déposées ou enregistrées de Sun Microsystems, Inc. aux Etats-Unis et dans d'autres pays. Toutes les marques SPARC, utilisées sous licence, sont des marques déposées ou enregistrées de SPARC International, Inc. aux Etats-Unis et dans d'autres pays. Les produits portant les marques SPARC sont basés sur une architecture développée par Sun Microsystems, Inc.

Les utilisateurs d'interfaces graphiques OPEN LOOK<sup>®</sup> et Sun<sup>™</sup> ont été développés de Sun Microsystems, Inc. pour ses utilisateurs et licenciés. Sun reconnaît les efforts de pionniers de Xerox Corporation pour la recherche et le développement du concept des interfaces d'utilisation visuelle ou graphique pour l'industrie de l'informatique. Sun détient une licence non exclusive de Xerox sur l'interface d'utilisation graphique, cette licence couvrant aussi les licenciés de Sun qui mettent en place les utilisateurs d'interfaces graphiques OPEN LOOK et qui en outre se conforment aux licences écrites de Sun.

CETTE PUBLICATION EST FOURNIE "EN L'ETAT" SANS GARANTIE D'AUCUNE SORTE, NI EXPRESSE NI IMPLICITE, Y COMPRIS, ET SANS QUE CETTE LISTE NE SOIT LIMITATIVE, DES GARANTIES CONCERNANT LA VALEUR MARCHANDE, L'APTITUDE DES PRODUITS A REpondre A UNE UTILISATION PARTICULIERE OU LE FAIT QU'ILS NE SOIENT PAS CONTREFAISANTS DE PRODUITS DE TIERS.



# *Contents*

---

Preface.....	xi
<b>1. SunISDN 1.0.4.....</b>	<b>1</b>
SunISDN Website.....	1
SunISDN 1.0.4 Features.....	2
Requirements.....	2
What is ISDN?.....	3
<b>2. Before You Begin.....</b>	<b>5</b>
Required Information.....	6
Terminology.....	6
Network Switch Type.....	7
Directory Numbers.....	7
Service Profile Identifier (SPID).....	7
Baud Rate.....	8
Point-to-Point (ptp) Interfaces.....	9
Multilink Protocol (RFC 1717).....	10

---

Dynamic Bandwidth Allocation .....	11
Data Compression .....	13
Security .....	13
Callback .....	17
Calling Line Identifier (CLI) .....	17
SunISDN 1.0.4 Directories and Files .....	18
<b>3. Installing SunISDN 1.0.4 .....</b>	<b>19</b>
Identifying and Removing Old ISDN Software .....	19
Ensuring SunISDN PPP and Asynchronous PPP Compatibility .....	20
Installing SunISDN 1.0.4 .....	21
Setting Up Your Environment .....	23
<b>4. Using the GUI to Configure SunISDN 1.0.4 .....</b>	<b>25</b>
Using isdntool .....	26
▼ To Run isdntool .....	27
ISDN Configuration File .....	30
▼ To Configure the ISDN Configuration File Using isdntool .....	30
PPP Configuration File .....	36
▼ To Configure the PPP Configuration File Using isdntool .....	36
<b>5. Using a Text Editor to Configure SunISDN 1.0.4 .....</b>	<b>51</b>
ISDN Configuration File .....	51
▼ To Configure the ISDN Configuration File .....	52
ISDN Configuration File Keywords .....	53

---

North American Switch Parameters .....	55
PPP Configuration File .....	56
▼ To Configure PPP Configuration File .....	56
The <code>ifconfig</code> Entry.....	57
PPP Configuration File Keywords.....	59
<b>6. Troubleshooting .....</b>	<b>67</b>
Common Setup Problems.....	67
Getting Help.....	73
▼ To Copy TRACE or LOG Files.....	73
Using <code>isdntrace</code> .....	74
Specifying the Input Device.....	75
Recovering the Input from File .....	76
Writing the Output to File .....	77
Modifying the Default Output Format.....	77
▼ To Modify the Default Output Format.....	78
Suppressing Time Stamping.....	79
Suppressing the Lost Data Indication.....	80
Using Multiple Command Line Options .....	80
Interpreting the Output from <code>isdntrace</code> .....	80
Using <code>ppptrace</code> .....	92
▼ To Run <code>ppptrace</code> .....	93
Problems Calling a Remote System.....	94
No Dialing Status Message.....	94
Connection Failure.....	95

---

Problems Communicating with a Remote System.....	95
icmp echo request Packets Do Not Arrive At the Remote End .....	95
icmp echo response Packets Are Not Returned .....	96
IP Routing Problems .....	97
IP Routing/Addressing Problems .....	97
Problems with Asynchronous PPP .....	98
<b>7. Status Messages.....</b>	<b>99</b>
Standard Messages Returned by CCITT Compliant Networks	99
<b>A. Configuration Example .....</b>	<b>105</b>
SunISDN Configuration Example .....	105
PPP Configuration File Example .....	110
<b>B. Quick SunISDN Installation     and Configuration.....</b>	<b>123</b>
▼ To Install and Configure SunISDN Quickly.....	123
Glossary .....	125
Index.....	137

## Figures

---

Figure 2-1	SunISDN Point-to-Point Configuration . . . . .	10
Figure 2-2	Password Authentication . . . . .	15
Figure 2-3	Call Acceptance Algorithm (PPP Password Authentication) . . . . .	16
Figure 2-4	SunISDN 1.0.4 Directories and Files . . . . .	18
Figure 4-1	The <code>isdntool</code> Main Window . . . . .	27
Figure 4-2	The ISDN Configuration File Windows . . . . .	28
Figure 4-3	The PPP Configuration File Windows . . . . .	29
Figure 4-4	The <code>isdntool</code> Main Window with ISDN Selected . . . . .	30
Figure 4-5	ISDN Configuration Options Window . . . . .	31
Figure 4-6	Physical Interface Field . . . . .	32
Figure 4-7	Network Type Submenu . . . . .	33
Figure 4-8	Configuration Options—Profile A . . . . .	34
Figure 4-9	Configuration Options-Local Addresses . . . . .	35
Figure 4-10	Main Menu Showing PPP Configuration Selected . . . . .	36
Figure 4-11	PPP Configuration Options Window . . . . .	37
Figure 4-12	PPP IP Interface Parameters Window . . . . .	38

---

Figure 4-13	PPP Connection Parameters Window . . . . .	40
Figure 4-14	PPP Security Configuration Window . . . . .	42
Figure 4-15	PPP Phone Configuration Window . . . . .	44
Figure 4-16	Advanced Options Configuration Window . . . . .	46
Figure 4-17	PPP Routing Configuration Window . . . . .	48
Figure 4-18	PPP Configuration Options Showing Connection Database .	50
Figure 5-1	SunISDN Point-to-Point Configuration Example. . . . .	58



## *Tables*

---

Table 2-1	Switch Type .....	7
Table 2-2	Bandwidth Parameters .....	11
Table 4-1	Switch Types for <code>isdntool</code> .....	33
Table 5-1	ISDN Configuration Parameters .....	53
Table 5-2	North American Switch Parameters .....	55
Table 5-3	Point-to-Point Protocol (PPP) Configuration Keywords .....	59



## *Preface*

---

The *SunISDN 1.0.4 User's Guide* describes how to install the SunISDN™ 1.0.4 software on your SPARC™-based computer. It provides procedures for configuring the PPP (point-to-point networking protocol) and ISDN (integrated system digital network) configuration files. It is intended for system administrators who configure and maintain IP/ISDN (Internet Protocol/Integrated Services Digital Network) networks. It assumes that you are familiar with the concept of ISDN and that you are familiar with the Solaris™ environment.

For information on SunISDN hardware installation, refer to the *SunISDN Hardware Installation Guide*.

### *How this Book is Organized*

This manual is organized as follows:

**Chapter 1, “SunISDN 1.0.4,”** provides a brief overview of SunISDN 1.0.4, including a list of new features and software and hardware required for installing this product.

**Chapter 2, “Before You Begin,”** describes the information you need to have and defines terms you need to know before you can install and configure the SunISDN 1.0.4 software.

**Chapter 3, “Installing SunISDN 1.0.4,”** describes how to install the SunISDN 1.0.4 software and verify your installation.

---

**Chapter 4, “Using the GUI to Configure SunISDN 1.0.4,”** shows how to use `isdntool` to configure both the ISDN and the PPP configuration files.

**Chapter 5, “Using a Text Editor to Configure SunISDN 1.0.4,”** shows how to configure the ISDN configuration files and the PPP configuration files using a text editor.

**Chapter 6, “Troubleshooting,”** provides troubleshooting information to help you detect and resolve problems with ISDN network configurations.

**Chapter 7, “Status Messages,”** lists problems that can occur if your ISDN and PPP configuration files are not set up properly. It also lists error messages that may display due to networking problems.

**Appendix A, “Configuration Example,”** provides an example of extracts from an ISDN configuration file and a PPP configuration file.

**Appendix B, “Quick SunISDN Installation and Configuration,”** provides guidelines for an experienced SunISDN user to quickly install and configure SunISDN 1.0.4.

## *UNIX Commands*

This document may not include specific software commands or procedures. Instead, it may name software tasks and refer you to operating system documentation or the handbook that was shipped with your new hardware.

The type of information you might need to use references for includes:

- Shutting down the system
- Booting the system
- Configuring devices
- Other basic software procedures

See one or more of the following:

- *Solaris 2.x Handbook for SMCC Peripherals* contains Solaris 2.x software commands.
- On-line AnswerBook™ for the complete set of documentation supporting the Solaris 2.x software environment.
- Other software documentation that you received with your system.

---

## Typographic Conventions

The following table describes the typographic changes used in this book.

Typeface or Symbol	Meaning	Example
AaBbCc123	The names of commands, files, and directories; on-screen computer output	Edit your <code>.login</code> file. Use <code>ls -a</code> to list all files. <code>machine_name%</code> You have mail.
<b>AaBbCc123</b>	What you type, contrasted with on-screen computer output	<code>machine_name%</code> <b>su</b> Password:
<i>AaBbCc123</i>	Command-line placeholder: replace with a real name or value	To delete a file, type <code>rm filename</code> .
<i>AaBbCc123</i>	Book titles, new words or terms, or words to be emphasized	Read Chapter 6 in the <i>User's Guide</i> . These are called <i>class</i> options. You <i>must</i> be root to do this.

## Shell Prompts

The following table shows the default system prompt and superuser prompt for the C shell, Bourne shell, and Korn shell.

Shell	Prompt
C shell	<code>machine_name%</code>
C shell superuser	<code>#</code>
Bourne shell and Korn shell	<code>\$</code>
Bourne shell and Korn shell superuser	<code>#</code>

---

## Ordering Sun Documents

SunDocs<sup>SM</sup> is a distribution program for Sun Microsystems technical documentation. Easy, convenient ordering and quick delivery is available from SunExpress<sup>TM</sup>. You can find a full listing of available documentation on the World Wide Web: <http://www.sun.com/sunexpress/>

Country	Telephone	Fax
United States	1-800-873-7869	1-800-944-0661
United Kingdom	0-800-89-88-88	0-800-89-88-87
France	05-90-61-57	05-90-61-58
Belgium	02-720-09-09	02-725-88-50
Luxembourg	32-2-720-09-09	32-2-725-88-50
Germany	01-30-81-61-91	01-30-81-61-92
The Netherlands	06-022-34-45	06-022-34-46
Sweden	020-79-57-26	020-79-57-27
Switzerland	155-19-26	155-19-27
Japan	0120-33-9096	0120-33-9097

## Sun Welcomes Your Comments

Please use the *Reader Comment Card* that accompanies this document. We are interested in improving our documentation and welcome your comments and suggestions.

If a card is not available, you can email or fax your comments to us. Please include the part number of your document in the subject line of your email or fax message.

- Email: [smcc-docs@sun.com](mailto:smcc-docs@sun.com)
- Fax: SMCC Document Feedback  
1-415-786-6443

## *SunISDN 1.0.4*

---



This chapter provides a list of SunISDN 1.0.4 features along with the software and hardware requirements for installing it. A brief overview of ISDN is also given.

The SunISDN 1.0.4 software provides transparent Internet Protocol (IP) connectivity for SPARC-based computer SBus systems across an ISDN (Integrated Services Digital Network).

### *SunISDN Website*

The information in this document is the most up-to-date as of its printing. See the SunISDN Website at <http://www.sun.com/ISDN> for additional information.

## *SunISDN 1.0.4 Features*

Following is a list of the major features of this release:

- Call Filter (`ip_spoofing`) configuration feature replaces point-to-multipoint configuration
- Coexistence of SunISDN PPP and SunSoft™ asynchronous PPP
- Improved kernel architecture for a more flexible PPP Multilink (MP) framework
- Improved handling of default route and dynamic IP address
- Additional troubleshooting capabilities from `isdntool`
- Client-side support for Security Dynamics' SecurID compatible with an access control encryption (ACE) security server using PAP-Token-CHAP for authentication

## *Requirements*

You need the following to run SunISDN 1.0.4.

- 10 MBytes of disk space is required to install SunISDN 1.0.4
- Solaris 2.3 or later

---

**Note** – Solaris 2.3 users *must* install Solaris patch 101242-10.

---

- SunISDN 1.0.4 software requires the following hardware support:
  - SBus systems such as Voyager™, SPARCstation™ 10 systems, and LX platforms. If your system does not have ISDN, you must add an ISDN SBus board.
  - NT-1 (required for North America) can be purchased via SunExpress.



## What is ISDN?

ISDN will do everything a modem does for connecting separate sites in addition to few other things. It connects your computer to a remote network. However, instead of speeds of 2400/9600 bps or 14.4 Kbps, typical with a modem, ISDN has a basic rate of 64 Kbps over one B channel. By using Basic Rate ISDN (BRI) at each desktop connected to your internal telephone switch, or Private Branch Exchange (PBX), you can create an all-digital network using telephone wires.

ISDN can use existing phone lines from your local telephone company to link to the network. The service provided by your telephone company is known as a “Basic Rate Interface” or BRI. It runs from your location to the telephone company’s central office switch. If the person you are calling also has ISDN capability, you can take advantage of ISDN’s higher data communications performance and features. If not, your network connection is limited to the slower transmission speed.

ISDN divides its information transmission capacity (bandwidth) into channels, each channel acting as a virtual telephone line. If you have two channels, which is standard with one ISDN line, then it is possible to have two telephone calls at once. There are two basic access channels:

- B channels can alternate between voice and circuit-data.
- D channel is used for call control messages when setting up a Basic Rate Interface and infrequently for packet data.

The following arrangement is typical for a single ISDN line:

- Two B channels at 64 Kbps each
- One D channel at 16 Kbps

These channels are not *physical* channels; you cannot see them as wires inside a telephone cable. Rather, they are *derived channels* created by the ISDN electronic components installed on your telephone line. Each B channel can be used for different purposes. The channel can initially be used for voice, then the same channel can be used for data or video. By aggregating both B channels, data can be transmitted simultaneously, thus doubling the data capacity of the ISDN line.

Primary Rate Interfaces (PRI) come with 23 B channels in the US, and 30 in Europe, plus one D channel at 64 Kbps on a 1.544 Mbps digital line. With PRI, the D channel is only used for call control; packet switching is not supported. “Multirate” calls can also be placed over PRI. Multirate ISDN calling provides wideband channels at 384 Kbps, 1536 Kbps, or any multiple of 64.

An analog call requires a number to identify a path through the maze of switches connecting the phone company’s network(s). At the other end, a person completes the connection or they do not. With a digital call, it’s still necessary to have a specific number to thread the phone company maze, but it is also necessary to negotiate with a computer system and its logical structure at the other end.

---

**Note** – Substantial portions of this section were taken from *A Catalog of National ISDN Solutions for Selected NIUF Applications-2nd Ed.* (North America ISDN User’s Forum.)

---

## Before You Begin

---



This chapter describes the information and terms you need to know before you can install and configure the SunISDN 1.0.4 software.

Only after your system is correctly configured can you do operations like ping, ftp, and sending email across ISDN. The operations of calling the right party and performing the necessary security handshakes are handled automatically in the background by the SunISDN software.

If your system does not have an ISDN board, you must first install one. See the *SunISDN Hardware Installation Guide* for details.

To verify that your system recognizes the ISDN hardware, type the following command and press Return:

```
hostname% ls /dev/isdn  
0/
```

This example shows that one ISDN device is installed (0/). If two devices are found the response will be 0/ 1/.

If your system does not respond with the correct number of ISDN devices, reboot your system.

After you halt your system, you will get either a > prompt or an ok prompt.

If you get a > prompt, type:

```
> b -r
```

If you get an ok prompt, type:

```
ok boot -r
```

## *Required Information*

Before you begin to configure the ISDN and PPP files, you need the following information from your phone company:

- **What are my ISDN numbers?**  
These are the telephone numbers assigned to your ISDN lines.
- **What is my switch type?**  
Most countries have only one switch type. The United States has three. Your local phone company can tell you which type it uses.
- **What is my Service Profile Identifier (SPID)?**  
One or more SPIDs may be specified by your phone company, along with the phone number. SPIDs are used only in North America.
- **Can I bring up data on both channels?**  
Your phone company will tell you whether you have a data/data line or a voice/data line.

## *Terminology*

The following sections define terms you need to know to successfully configure your ISDN and PPP files.

## *Network Switch Type*

The switch type refers to the central office switch of your ISDN service carrier or your local PBX. Select your switch type from the list in Table 2-1:

*Table 2-1* Switch Type

<b>Switch Type</b>	<b>Country</b>
AUSTEL (au1)	Australia
ETSI (etsi)	Europe
FT VN6 (vn6)	France
FT VN3 (vn3)	France
DBT 1TR6 (1tr6)	Germany
HKT (hkt)	Hong Kong
NTT INS64 (ntt)	Japan
NTT DSM100 (dms)	North America
AT&T 5ESS PTP/MTP (5ess)	North America
National ISDN-1 and ISDN-2 (ni2)	North America
SWD-ETSI (swd-etsi)	Sweden
BT ISDN2 (bt2)	United Kingdom

## *Directory Numbers*

You have only one phone number if you have a Point-to-Point (PTP) switch type. You may have one or two phone numbers assigned to the ISDN line if you have any other switch type. Obtain these numbers from your local phone company.

## *Service Profile Identifier (SPID)*

Service Profile Identifier (SPID) is used in North America to identify different combinations of subscriber equipment. If you are connected to an AT&T/PTP switch, you may not need an SPID. If you are connected to a DMS, AT&T/MTP (multipoint) or NI-1 or NI-2 switch, you may have one or two SPIDs assigned to each ISDN line by the phone company.

---

**Note** – Confirm the SPID format with your ISDN provider.

---

For example, Pacific Bell uses the following SPID formats:

- **For AT&T 5ESS custom multipoint**, the SPID is `01dir number0`, where *dir number* is the 7-digit directory number. For example, if the *dir number* is 2223334, then the SPID is 0122233340 for the first line and 1122233340 for the second.
- **For ATT 5ESS NI-1 or NI-2**, the SPID is `01dir number0TID`, where *dir number* is the 7-digit directory number and *TID* is the transmission ID number. For example, if the *dir number* is 2223334, and the *TID* is 00 (*TID* is typically 00), then the SPID number is 012223334000.
- **For DMS100 custom or NI-1/NI-2**, the SPID contains the area code and 7-digit directory number. For example, if your area code is 415 and the directory number is 2223334, the SPID is 4152223334. Obtain the switch profile number from your phone company.

## Baud Rate

Your phone company can tell you which baud rate their switches support. A 64 Kbps baud rate is set by default. You may change the baud rate to 56 Kbps.

If any part of the connection between the local and the remote site is 56 Kbps then the entire connection must run at 56 Kbps. It is best to begin with 64 Kbps to see if it is possible to make a connection. If part of the network will not support that speed then reset the speed in the `isdntool`. It may be necessary to set `Force56` for incoming calls if there is a problem receiving an ISDN connection. If `path_stat`, (`/opt/SUNWisdn/bin/path_stat`), the `log` or `isdntrace` show that a call is being connected and packets are being sent at both ends but neither side is receiving packets, it may indicate that there is a mismatch between the baud rate expected and the baud rate delivered.

---

**Note** – `path_stat` is a very convenient tool for monitoring your connection status.

---

This may happen even if the PPP configurations are set correctly at both ends of the call. In that case, use `Force56`, which forces the baud rate to 56 Kbps regardless of the configured values.

---

## *Point-to-Point (ptp) Interfaces*

PPP point-to-point (ptp) interfaces are named sequentially (`ifppp0`, `ifppp1`, `ifppp2`, and so on).

---

**Note** – A single point-to-point interface *cannot* be used to create a direct connection between more than two systems.

---

Figure 2-1 shows a typical PPP point-to-point configuration that illustrates this principle in the following way:

Two systems are attached to separate local area networks. Point-to-point IP/dial-up interfaces are used to create a direct connection between them across the ISDN.

Point-to-point IP/dial-up interfaces are defined by specifying a source address (or point of attachment) and a unique destination address for the direct connection. There is only one possible destination to which IP datagrams can be directed after they are passed to a given point-to-point IP/dial-up interface. As a result, the same IP address can be used as the source address for multiple point-to-point interfaces.

It is possible, as shown in Figure 2-1, to use the same address (for example, `hare`) for both the IP/PPP address and the IP/ethernet address and thus reduce the number of IP addresses required.

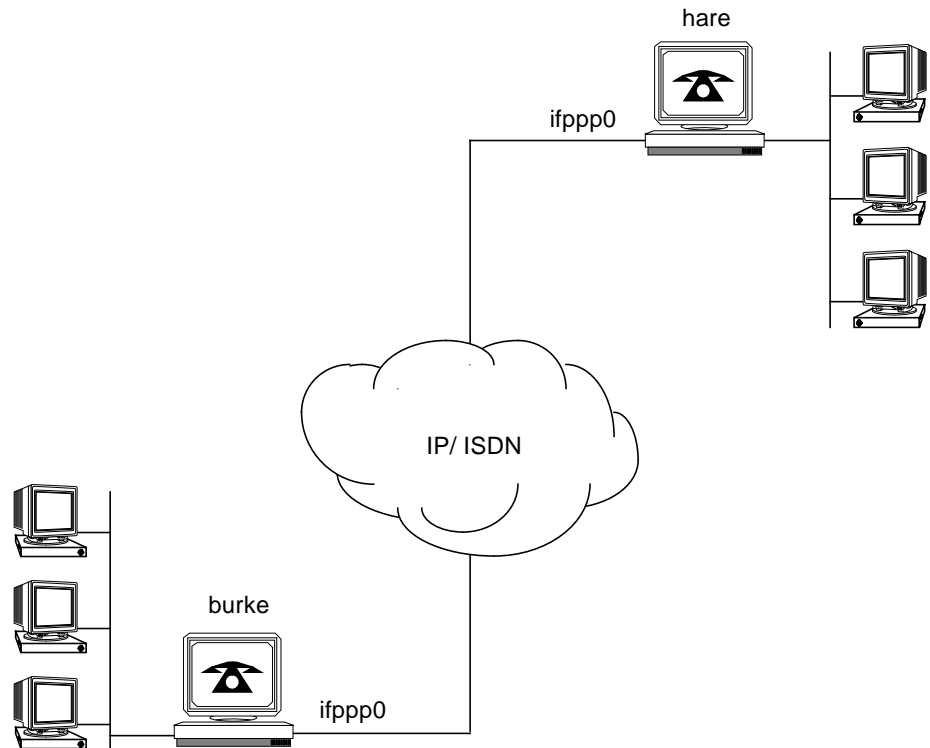

Figure 2-1 SunISDN Point-to-Point Configuration

The point-to-point interface logically connects the host machine with one peer host. Only IP traffic to or from the peer host is routed through this interface. When an `ifppp` interface is configured, two IP addresses are assigned. This type of interface is well suited to support a remote or nomadic machine.

### *Multilink Protocol (RFC 1717)*

Multilink Protocol (MP) is based on a Link Control Protocol (LCP) option that permits combining multiple physical links into a “bundle.” The bundle provides a virtual link with greater bandwidth than any of the constituent members. A system indicates to its peer that it is willing to do multilink by



sending the multilink MRRU (Maximum Received Reconstructed Unit) option as part of the initial LCP option negotiation. This negotiation indicates the following information:

- The system offering the option is capable of combining multiple physical links into one virtual link.
- The system is capable of receiving upper layer Protocol Data Units (PDU) fragmented using the multilink header and reassembling the fragments back into the original PDU for processing.
- The system is capable of receiving PDUs of size  $n$ , where  $n$  is specified as part of the option even if  $n$  is larger than the maximum receive unit (MRU) for a single physical link.

Multilink Protocol RFC 1717 is the latest version of MP and is the current standard in the industry. Following the current industry standard creates the widest possible interoperability with other vendors.

## *Dynamic Bandwidth Allocation*

The PPP configuration file keywords in Table 2-2 are all related to dynamic bandwidth allocation (DBA). To prevent call collision, only one side of the line connection can control adding and deleting links. Typically, you would set `bandwidth_controller` to **on** on the caller's side and **off** on the called side.

*Table 2-2* Bandwidth Parameters

<b>Keyword</b>	<b>Setting</b>
<code>bandwidth_controller on   off</code>	defaults to no
<code>hiwat</code>	defaults to 60%
<code>lowat</code>	defaults to 10%
<code>hicnt</code>	defaults to 2
<code>locnt</code>	defaults to 20
<code>clamp</code>	defaults to 1
<code>bandwidth</code>	defaults to 2 (number of links)
<code>link_retry_count</code>	defaults to 3
<code>link_suspend_timer</code>	defaults to 300

The dynamic bandwidth allocation algorithm is built into the PPP manager and works as follows: Both `hiwat` and `lowat` are specified as a percentage of available link bandwidth (percentage of 56 Kbps or 64 Kbps for Basic Rate ISDN). Both these figures are used as thresholds when allocating more than one B channel to a single connection for higher transfer rates.

The decision to add a link is made when either the aggregated input or aggregated output rate consistently exceeds the `hiwat` threshold for `hicut` sampling periods.

The decision to delete a link is made when the aggregate full-duplex rate is consistently below the `lowat` for `locnt` sampling periods.

Thus, `hicut` and `locnt` can be used to avoid hysteresis.

The keyword `clamp` specifies the number of channels that will stay permanently connected, once they have been added by the bandwidth controller, unless the connection is cleared by an external event. Further, all links, including clamped links, will be brought down when the `inactivity_timer` expires.

There are two additional keywords that relate to bandwidth on demand on a machine with `bandwidth_controller` set to `on`. These keywords deal with temporarily disabling (suspending) and re-enabling (resuming) links on a path.

The keyword `link_retry_count` gives the number of repeated connection attempts to be made on a link that is failing to complete the connection. The default value for this keyword is 3, so that 3 attempts are made before the link is temporarily suspended.

The keyword `link_suspend_timer` gives the amount of time, in seconds, that the link will be suspended before it is added back to the set of links that will be used for bandwidth on demand (resumed). The default value for this keyword is 300 seconds (5 minutes).

The first (or only) link on a path is unaffected by these keywords. Connection attempts on that link are retried indefinitely, and the link is never suspended.

## *Data Compression*

Two compression types are offered with SunISDN: STAC and STAC Ascend. The latter supports the Ascend proprietary implementation of the Compression Control Protocol (ccp). The STAC compression algorithm expects packets to be decompressed in the same order they were compressed. You must use MP because only MP guarantees packet sequencing and reordering.

## *Security*

All security features described in this section except Calling Line Identifier (CLI) are set in the PPP configuration file.

### *Challenge Authentication Password (CHAP) and PPP Authentication Password (PAP)*

PPP makes provision for two different password exchange services based on the PPP password authentication protocol. When PPP password authentication is enabled in `SUNwisdn/isppp.cf`, the calling system identifies itself by presenting a PPP identifier (either `pap_id` or `chap_name`) and PPP password (either `pap_password` or `chap_secret`) to the called system as part of the PPP negotiation process. The called system compares the PPP identifier it receives against the remote PPP identifier for each authorized path in its configuration file. If no match is found, the call is disconnected. If the incoming PPP identifier matches an entry in the IP/ISDN map, the called system compares the PPP password it received against the remote PPP password expected for the path that provided the matching PPP identifier. If these passwords do not match, the call is disconnected; if these passwords do match, the two systems continue with the PPP negotiation process and eventually start IP.

Because the identifier is used to make an initial identification of the presumed caller, it is essential that each remote system is assigned a unique identifier in the IP/ISDN map. If duplicate identifiers are presented by two different systems, both calls will be accepted provisionally against the first matching path. However, one of the calls will be refused unless they both present the same password. By convention, the identifier sent by each system when it initiates a call is configured to be its primary IP address (host name).

As for all password-based security schemes, the network only remains secure for as long as the PPP identifiers and PPP passwords used remain undisclosed. The primary difference between CHAP and PAP is that CHAP parameters are encrypted during transmission while PAP parameters are not. It is therefore easier for a determined hacker to impersonate an authorized caller using PAP.

---

**Note** – You can use either CHAP or PAP. But you cannot mix PAP and CHAP between the local and remote machines except when using PAP-Token-CHAP. When using multiple paths, each path name and password must be unique.

---

Figure 2-2 on page 15 shows the way in which PPP identifiers and passwords are exchanged between systems. Figure 2-3 on page 16 shows the algorithm used by the connection manager to determine whether an incoming call is accepted or refused when CHAP or PAP is enabled on its own.

### *PAP-Token-CHAP*

Both PAP and CHAP authentication schemes are combined with the use of a security card (for example, the Enigma DES Gold Card or Security Dynamics SecurID) to provide even greater security than PAP or CHAP alone. PAP-Token-CHAP is used to individually authenticate all channels of an MP call. If the remote system requires security card authentication PAP will be used to authenticate the first channel of an MP call. When additional channels are added, CHAP is used to authenticate the new channel and works without the security card.

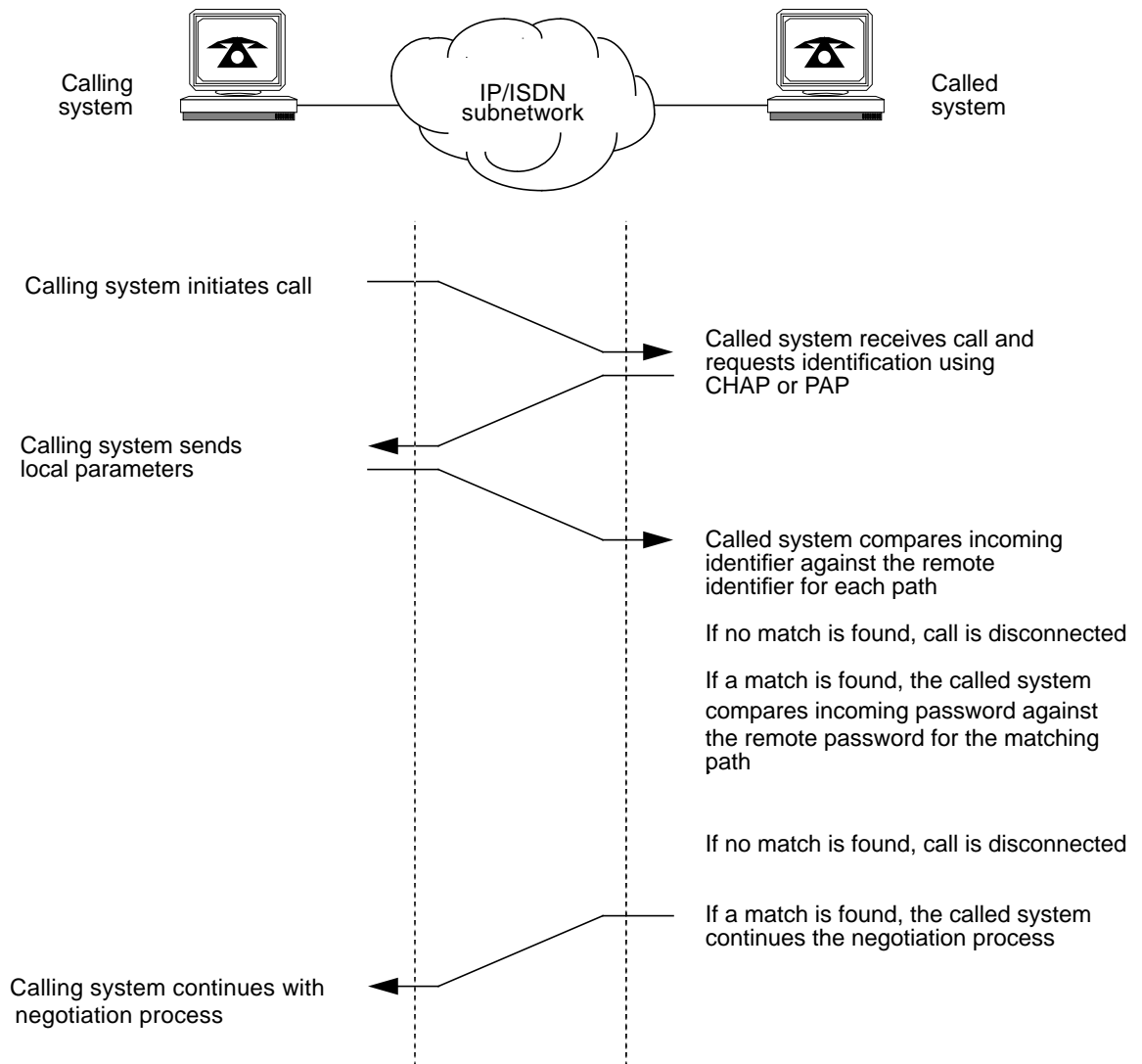

Figure 2-2 Password Authentication

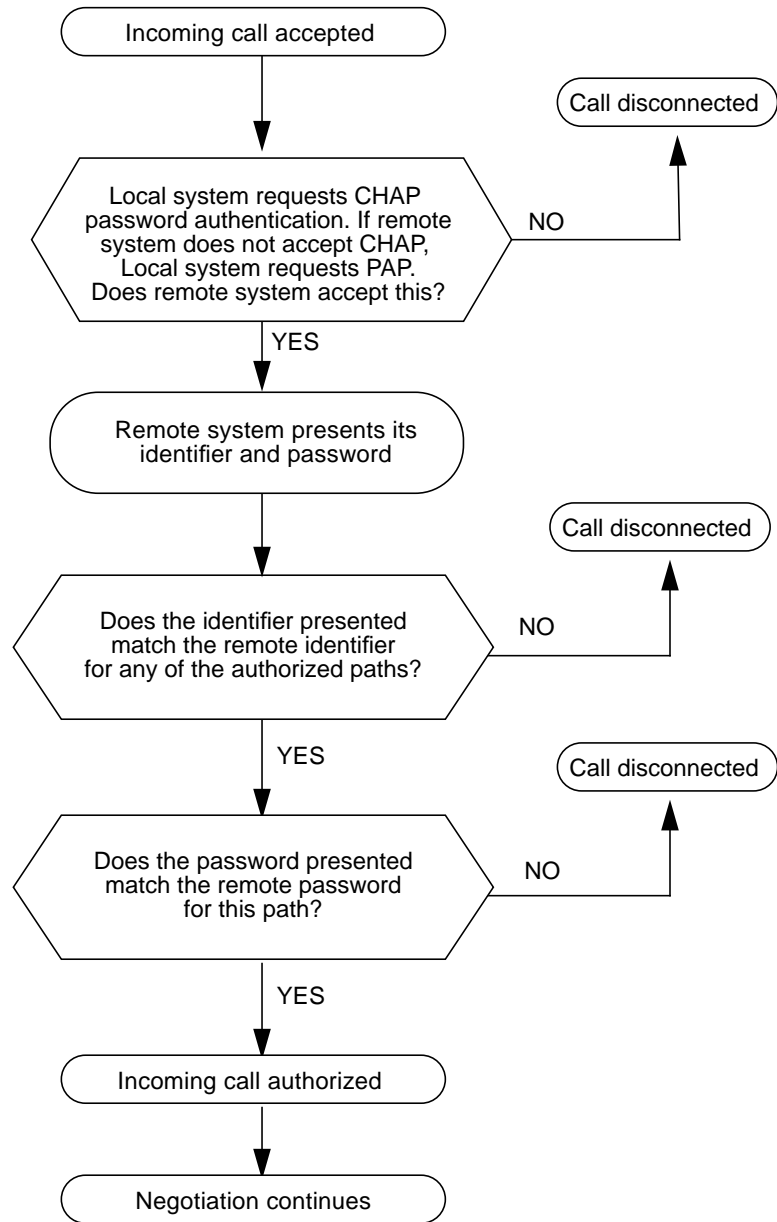

Figure 2-3 Call Acceptance Algorithm (PPP Password Authentication)

## Callback

Callback means that the connection will not be completed until the callback action is completed. Callback may be set in conjunction with PAP or CHAP. If Callback is set to **on**, the remote host immediately hangs up and calls back the local host. The local host should leave the `reenable_timeout` set to 30 seconds but may need to experiment with the value based on network conditions.

## Calling Line Identifier (CLI)

When CLI is turned on, the switch to the remote site confirms that the physical calling number matches the `cc_calling_nb` entry in the ISDN configuration file. A pass/fail flag is set and passed to the local site; the call is connected only if a pass signal is received.

---

**Note** – Do not confuse CLI with Use Caller ID. See Table 5-3 on page 59 for a definition of the `use_caller_id` parameter.

---

CLI is *not* supported consistently by all networks and is *not* supported across network boundaries. It is often offered on a subscription basis only. If CLI is not available, one of the other access restriction mechanisms should be used to ensure the integrity of your network connection.

---

**Note** – Always check that your local ISDN carrier supports CLI and that you have subscribed to this service before enabling CLI. If you cannot use CLI, use PPP password authentication or callback to protect your network.

---

When CLI and PAP/CHAP password authentication are enabled, the connection manager first identifies the caller using its network-inserted calling address, and then checks its initial decision using password authentication.

If the network does not support CLI or no `calling_address` is passed, then the PAP/CHAP password is used to authenticate the call.

## SunISDN 1.0.4 Directories and Files

Figure 2-4 shows the hierarchy of directories and files for SunISDN 1.0.4.

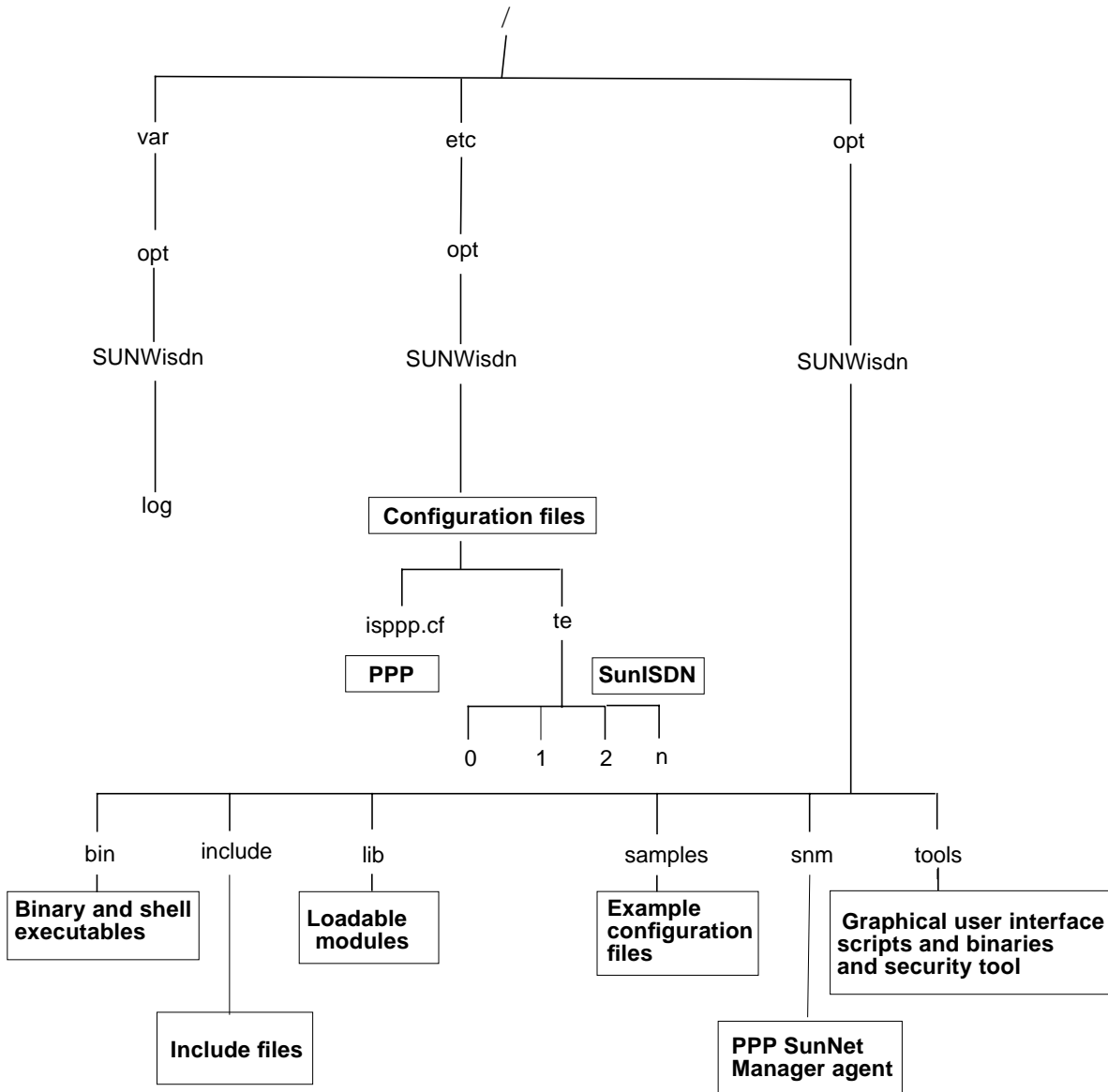

Figure 2-4 SunISDN 1.0.4 Directories and Files



## Installing SunISDN 1.0.4



This chapter describes how to install the SunISDN 1.0.4 software. It also shows you how to verify that your Solaris software environment has the necessary software packages to run SunISDN 1.0.4.

### *Identifying and Removing Old ISDN Software*

Your Solaris software environment must contain PPP and ISDN packages to run SunISDN 1.0.4 software:

To check for old versions of SunISDN software, use the `pkginfo` command piped to the UNIX `grep` (find) command:

- ◆ **Type the following at your system prompt and press Return.**  
The `isdn` package and `ppp` package are then displayed.

```
hostname% pkginfo | grep ISDN
system      SUNWippk  SunISDN PPP kernel Drivers and Modules
application SUNWisdn  SunISDN User Programs and Switch Software
application SUNWisdnh SunISDN Interface Developer Source Code
application SUNWisdni SunISDN IP/PPP over ISDN Connection Manager
application SUNWisdnm SunISDN Loadable Binary Interface Modules
application SUNWisdnu SunISDN Utilities (Graphical User Interface)
```

This is an example from a system using the SunISDN 1.0.3 software. Results may differ, depending on your version of the software.

**Note** – If you find earlier versions of the software, SunLink ISDN or SunISDN, or packages SUNWisdna or SUNWisdnb they *must be removed*.

---

♦ **To remove packages, become superuser and type:**

```
# pkgrm package name
```

The following screen shows a sample response from pkgrm:

```
# pkgrm SUNWisdnv
The following package is currently installed:
  SUNWisdnv SunISDN 1.0.2 Tools
Do you want to remove this package?
```

### *Ensuring SunISDN PPP and Asynchronous PPP Compatibility*

If you have both asynchronous PPP and SunISDN 1.0.3 loaded on your machine, you must also remove the following asynchronous PPP packages: SUNWapppr, SUNWapppu, and SUNWpppk.

**Note** – If you have installed the patch for SunISDN 1.0.3, removing the asynchronous PPP packages is not necessary.

---

♦ **Become superuser, and remove each of the asynchronous PPP packages (SUNWapppr, SUNWapppu, and SUNWpppk):**

```
# pkgrm package name
```

Re-install asynchronous PPP according to its documentation.

## Installing SunISDN 1.0.4

Follow these procedures to install SunISDN:

**1. Become superuser.**

**2. Follow the instructions that came with the CD to install the packages.**

The following menu is displayed, listing the available packages on the CD:

```
The following packages are available:
1 SUNWcpppk Common PPP Kernel Device Drivers
  (sparc) 1.0.0
2 SUNWisdn  SunISDN 1.0.4 User Programs and Switch Software
  (sparc) 1.0.4
3 SUNWisdnh SunISDN 1.0.4 Interface Developer Source Code
  (sparc) 1.0.4
4 SUNWisdni SunISDN 1.0.4 IP/PPP over ISDN Connection Manager
  (sparc) 1.0.4
5 SUNWisdnm SunISDN 1.0.4 Loadable Binary Interface Modules
  (sparc) 1.0.4
6 SUNWisdnu SunISDN 1.0.4 Utilities (Graphical User Interface)
  (sparc) 1.0.4

Select package(s) you wish to process (or 'all' to process all packages).
(default: all) [?,??,q]:
```

---

**Note** - pkgadd keeps recycling through its script once it's started. Therefore, you must quit (q) the program the second time this screen comes up.

---

As each package is processed, a message is displayed that indicates what package is being installed. The script displays installing, followed by a list of files being installed. Next, it says installing post install script. Finally, copyright and licensing information are displayed. After each package is installed, a prompt asks if you want to continue the installation.

**3. Type y and press Return.**

This process is repeated for each SunISDN 1.0.4 software package.

**Note** – If the program attempts to install a package that already exists, a message similar to the following is displayed and you are prompted to continue:

```
The following files are already installed on the system and are
being used by another package:
    /usr/kernel/drv/lcp
    /usr/kernel/drv/pppmgt
    /usr/kernel/drv/ifppp

Do you want to install these conflicting files [y,n,?,q] y
```

**4. Type `y` and press Return.**

**5. After completing the installation, verify that the SunISDN 1.0.4 software packages have been installed.**

To list the installed SunISDN software packages, type the `pkginfo` and `grep` commands and press Return.

```
# pkginfo | grep isdn
application SUNWisdn  SunISDN 1.0.4 User Programs and Switch Software
application SUNWisdnh SunISDN 1.0.4 Interface Developer Source Code
application SUNWisdni  SunISDN 1.0.4 IP/PPP over ISDN Connection Manager
application SUNWisdnm SunISDN 1.0.4 Loadable Binary Interface Modules
application SUNWisdnu SunISDN 1.0.4 Utilities (Graphical User Interface)
```

**6. Verify the PPP package.**

Enter the following and press Return.

```
hostname# pkginfo | grep cppk
system      SUNWcppk  Common PPP Kernel Device Drivers
```

**7. Add `/opt/SUNWisdn/bin` and `/opt/SUNWisdn/tools` to your search path. (See “Setting Up Your Environment” in this section.)**

**Note** – Do not reboot your system until after you configure both the ISDN and PPP configuration files.

## Setting Up Your Environment

You must add or modify the definitions for these environment variables as superuser. This enables you to run the SunISDN software utilities as root, which is essential if you want to fully configure, start, and stop the SunISDN software subsystem.

To distinguish whether you are using Bourne or C-shell as superuser, type `more /.profile` and `more /.cshrc`. Only one of these files exists. Proceed with the instructions for your shell type.

Bourne shell users should modify `/.profile` to add these paths to the existing definitions. A simple way to do this so that the existing definitions are preserved is shown below. Add these lines to your existing file:

```
PATH=$PATH:/opt/SUNWisdn/bin:/opt/SUNWisdn/tools

export PATH
```

C-shell users should add these lines to the existing `/.cshrc` to add these paths to the existing definitions. Use the following example to ensure that the existing definitions are always preserved:

```
set path = ($path /opt/SUNWisdn/bin /opt/SUNWisdn/tools)
setenv LD_LIBRARY_PATH /usr/openwin/lib:/usr/lib
```



## Using the GUI to Configure SunISDN 1.0.4

---



The graphical user interface (GUI) for SunISDN is called `isdntool`. You can use `isdntool` to configure files as well as detect and diagnose problems with your IP/ISDN network configuration.

This chapter shows you how to use `isdntool` to configure both the ISDN and PPP configuration files. Chapter 5 gives instructions for configuring the files using a text editor. You can configure the files using either method, but you cannot mix them.

The ISDN configuration files contain phone connection information such as your local carrier and line number. The PPP configuration file specifies remote parameters including security and identification information.

Both ISDN and PPP configuration files are formatted for keyword value entries. Information for these values such as local calling numbers, switch type, service profile ID (SPID), and local and remote IP addresses are provided by your local phone/ISDN provider and system administrator.

When configuring SunISDN 1.0.4, you will provide information for both the local and remote systems. Each type of system is defined as follows:

- A *local* system is the system on which you are currently configuring the SunISDN 1.0.4 software. The SunISDN configuration files (`/etc/opt/SUNWisdn/te/0, 1` and so on) contain the information that defines how the local system is configured, such as local carrier (switch type), and line number. The configuration file for the first ISDN board is `te/0`; the configuration for the second ISDN board is `te/1`, and so on.

- A *remote* system is the system that the local system recognizes and can reach across the ISDN. Each remote system must be connected to the ISDN. `/etc/opt/SUNWisdn/isppp.cf` contains the information that defines which remote systems are known to the local system and how it communicates with them, along with security information.

---

**Note** – Do not reboot your system until after you configure *both* the ISDN and PPP configuration files.

---

## *Using* `isdntool`

`isdntool` inactivates any fields that do not apply to your configuration. For example, if you choose point-to-point protocol, fields that pertain to multilink protocol become inactive.

The fields in `isdntool` are color-coded as follows:

- Light gray indicates a read-only field
- Green indicates the default values.
- Light yellow indicates a field that may need to be set in some instances.
- Bright yellow indicates a required field.

The default configuration for the Sun three-button mouse designates the buttons as SELECT (left), ADJUST (middle), and MENU (right). Use SELECT both to display menus and to select menu items in `isdntool`. Use MENU to access on-line help. Help is available for all fields and action buttons in the `isdntool` windows. To access on-line help, double-click MENU on the field or action button where you want help.

The action buttons include the following;

- Add—Click after typing in new information to add it to the file.
- Defaults—Click to restore default values to the window.
- Reset—Click to revert to the most recently saved values.
- OK—Click to apply changes to all configuration files and close the window



## ▼ To Run isdntool

1. Type the following command in a shell window:

```
hostname% xhost +
```

2. Become superuser.

3. Go to your ISDN tools directory:

```
# cd /opt/SUNWisdn/tools
```

4. To start isdntool, type the following and press Return:

```
# ./isdntool&
```

The isdntool main window is displayed (Figure 4-1).



Figure 4-1 The isdntool Main Window

From the isdntool main window, you can access the windows to configure the isdn and ppp configuration files. You can also access the troubleshooting tools: isdntrace, and path\_stat.

When you configure both the isdn and ppp configuration files, use the isdntool Main window to Start, Stop, or Restart isdn.

The `isdntool` windows used for configuring and troubleshooting the ISDN configuration file are shown below.

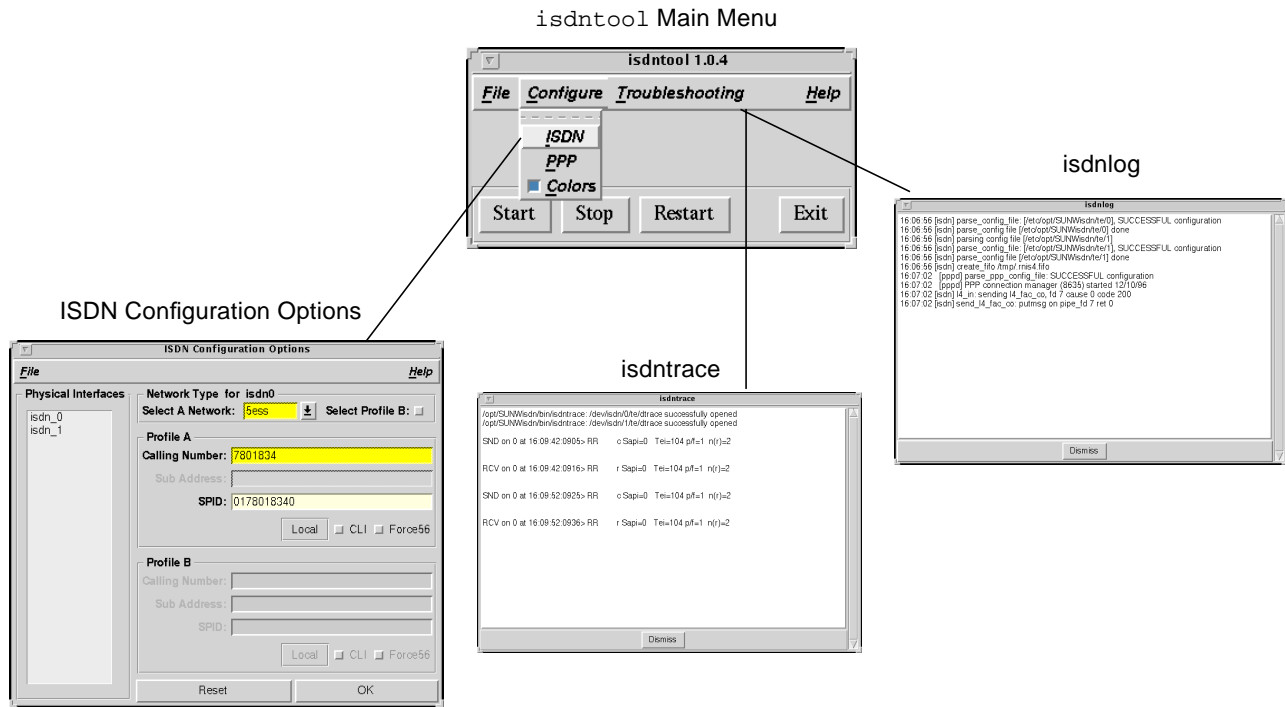

Figure 4-2 The ISDN Configuration File Windows

The isdntool windows for configuring the PPP configuration file are shown below.

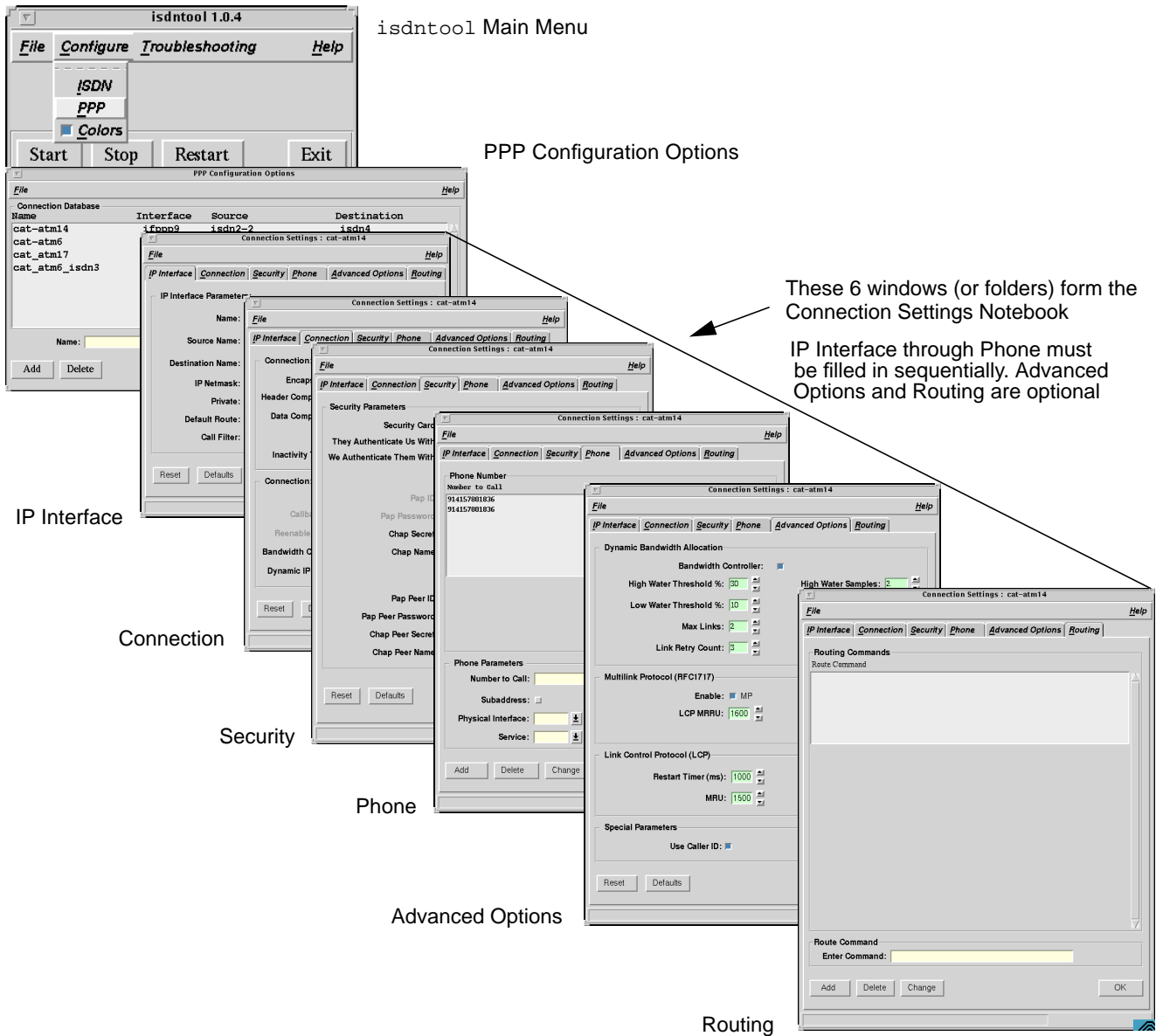

Figure 4-3 The PPP Configuration File Windows

## ISDN Configuration File

SunISDN 1.0.4 creates ISDN configuration templates under `/etc/opt/SUNWisdn/te` for each ISDN board on your system. (`/etc/opt/SUNWisdn/te/0` is the configuration file for the first ISDN interface, `/etc/opt/SUNWisdn/te/1` is the file for the second ISDN interface, and so on.)

---

**Note** – You must have the information required from your local phone company described in Chapter 2, “Before You Begin,” before proceeding with these procedures.

---

### ▼ To Configure the ISDN Configuration File Using `isdntool`



Figure 4-4 The `isdntool` Main Window with ISDN Selected

#### 1. Select ISDN from the Configure menu.

The ISDN Configuration Options window is displayed (Figure 4-5).

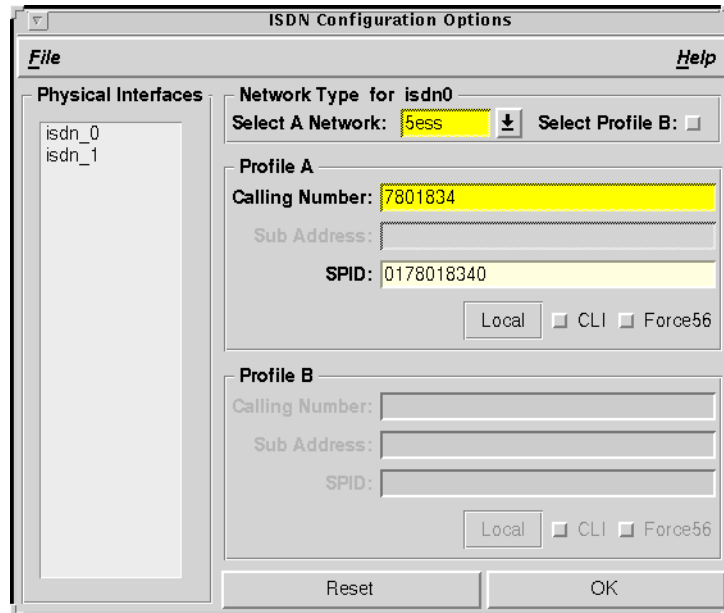

Figure 4-5 ISDN Configuration Options Window

**2. Set ISDN parameters using the ISDN Configuration Options window.**  
The following steps walk you through setting the parameters.

The `isdntool` captures the physical ISDN interfaces available and displays them in the Physical Interfaces field (Figure 4-6). The numbers shown in this window represent your ISDN interfaces. For example, `isdn_0` represents `te/0`.

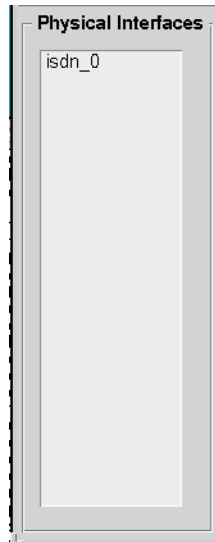

Figure 4-6 Physical Interface Field

**3. Double-click on the appropriate physical interface.**

If only one physical interface exists, you still must double-click to select it.

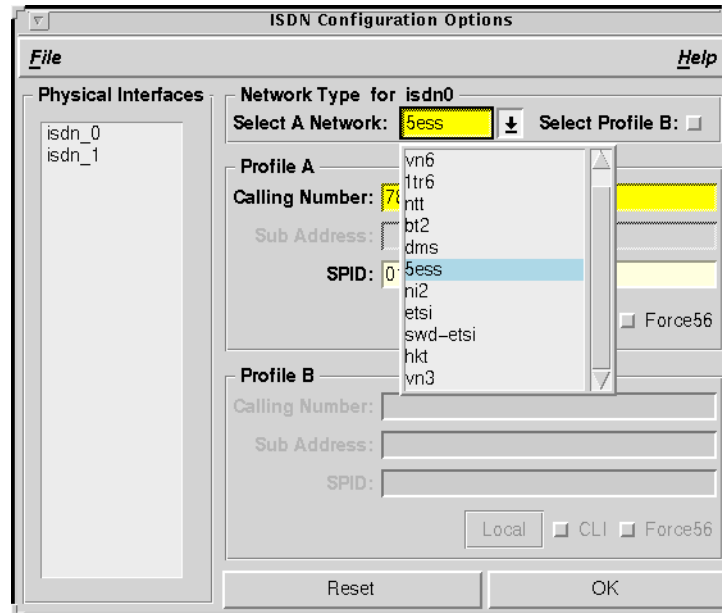

Figure 4-7 Network Type Submenu

**4. Pull down the Network Type submenu and select the keyword for the switch type used by your phone company.**

This field is required. Table 4-1 lists the possible switch types.

Table 4-1 Switch Types for isdntool

Country	Switch Type	Keyword
Australia	AUSTEL	au1
Europe	ETSI	etsi
France	Version Nationale Euro Numeris 3	vn3
France	Version Nationale Euro Numeris 6	vn6
Germany	DBT 1TR6	1tr6
Hong Kong	HKT	hkt
Japan	NTT INS-64	ntt
North America	National ISDN-1 and ISDN-2	ni2

Table 4-1 Switch Types for isdntool (Continued)

Country	Switch Type	Keyword
North America	AT&T 5ESS PTP/MTP	5ess
North America	NT DMS100	dms
Sweden	SWD-ETSI	swd-etsi
United Kingdom	BT (ISDN-2)	bt2

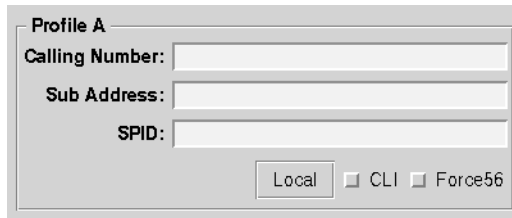

Figure 4-8 Configuration Options—Profile A

**5. Set up a Profile.**

Use Profile A for one interface and one B channel configuration.  
 Use Profile B for a multipoint or NI-2 connection.

If two (or more) profiles were assigned, use both Profile A and Profile B.

**a. Type the phone number for *your* ISDN line in the Calling Number field.**

This field is required. Type your phone number as a local number. In the United States, you would use only your seven-digit number, without the area code, for example, 5551212.

- Type the subaddress in the Sub Address field. This can be supplied by your telephone company or you can make up your own subaddress.

---

**Note** – The Sub Address field is not used in North America.

---



**b. Type your Service Profile Identifier (SPID) in the SPID field.**

This field is required in North America for AT&T, multipoint, all DMS, and all NI-1 and NI-2 connections. It is *not* required for AT&T point-to-point (PTP). SPID numbers are not used outside North America.

If more than one SPID is specified by the phone company, along with the phone number, use it. See “Service Profile Identifier (SPID)” on page 7.

- **If you have subscribed to CLI, click the CLI button to use the Calling Line Identifier.**

See “Calling Line Identifier (CLI)” on page 17, for a description of this security feature.

- **If you want to enforce a transfer rate of 56 Kbps, click the Force56 button.**

This forces the slower of two baud rates. See “Baud Rate” on page 8. If you have trouble transferring data, it may be that some connection point between you and your destination uses a 56Kbps baud rate. In that case, using Force56 should solve the problem.

- **If you have reserved several phone numbers, click the local button.**

The Local Addresses window is displayed. Local addresses are simply additional phone numbers assigned to your ISDN lines. For example, if you are assigned 5551234 and 5551235, you would put 5551234 in the calling number field and 5551235 in the Local Addr 1 field.

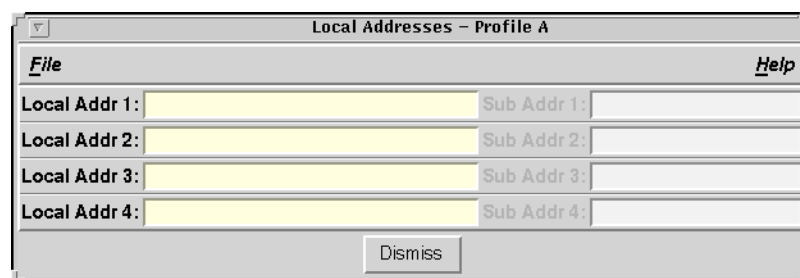

Figure 4-9 Configuration Options-Local Addresses

- **If you have additional phone numbers and subaddresses, type them in.**

**6. Click the Apply button to update /etc/opt/SUNwisdn/te/0, 1...n.**

A message confirming that ISDN is configured is displayed in the Main window.

## PPP Configuration File

Your PPP configuration file is preconfigured. Since some parameters are unique to your environment, you must edit this file.

---

**Note** – When configuring your PPP configuration file, refer to Table 5-3 on page 59 for a list and description of each parameter.

---

### ▼ To Configure the PPP Configuration File Using `isdntool`



Figure 4-10 Main Menu Showing PPP Configuration Selected

- 1. Select PPP from the Configure menu (Figure 4-10).**  
The PPP Configuration Options window is displayed (Figure 4-11). This is the first of several windows you will use to configure your PPP configuration file.

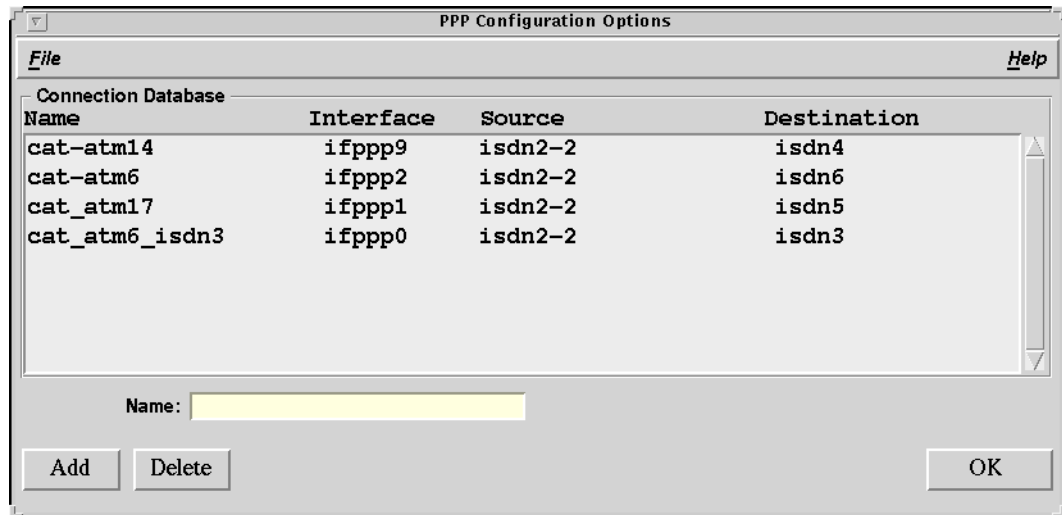

Figure 4-11 PPP Configuration Options Window

2. **Type an identifying name for the remote machine in the Name field.**  
This can be the remote machine's host name, IP address, or any other identifier you choose.
3. **Click the Add button to set this configuration,.**  
The information you typed is displayed in the scrolling list at the top of this window (Figure 4-11) and the IP Interface Parameters window is displayed (Figure 4-12). The IP Interface window is the first of six windows (or folders) in the Connection Settings notebook.

You will use the windows in the connection notebook to configure the parameters for this connection. You must complete the first four folders sequentially. The last two folders are optional. As you complete each folder, save the parameters.

4. **When you have configured all the necessary parameters for this connection, click the OK button in the PPP Configuration Options window (Figure 4-11) to save the connection database to your `isppp.cf` file.**



**Caution** – The parameters you set for this connection using the connection notebook are not saved to your `isp_ppp.cf` file until you click the OK button in the PPP Configuration Options window (Figure 4-11.)

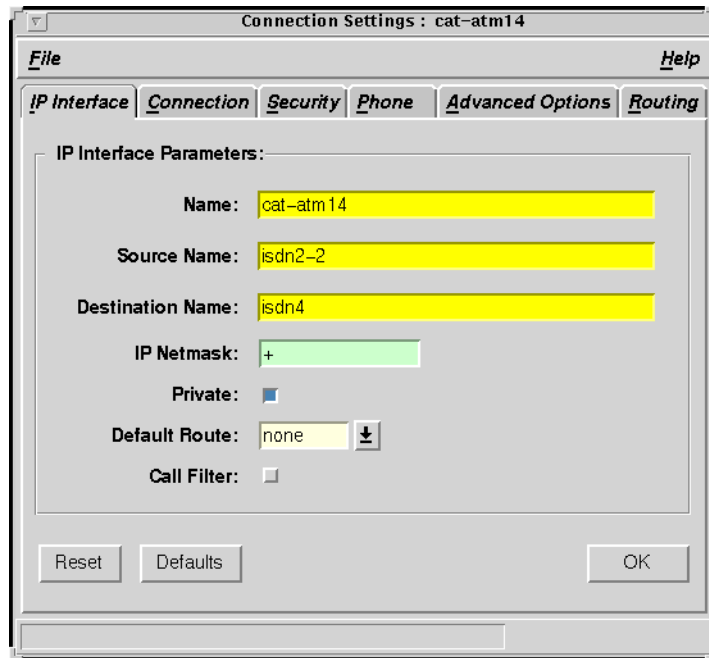

Figure 4-12 PPP IP Interface Parameters Window

▼ **To Configure IP Interface Parameters**

**1. Check the name in the Name field.**

If you made a typographical error or want to change the name for this connection, edit the Name field in this window.

**2. Type your local machine's host name or IP address in the Source Name field.**

---

**3. Type the remote machine's host name or its IP address in the Destination Name field.**

The IP Netmask default setting is + and requires no further input.

---

**Note** – If you change the netmask default setting, do not use a hex format (ff.ff.ff.f0). The following formats are acceptable: 255.255.255.240 or 0xfffff00.

---

**4. Select Private or Default Route.**

Select this option to prevent the `in.routed(1M)` network routing daemon from advertising the interface. Use on-line help or see Table 5-3 on page 59 for detailed information.

**5. Select Connection to configure connection parameters.**

The Connection Settings window is displayed (Figure 4-13).

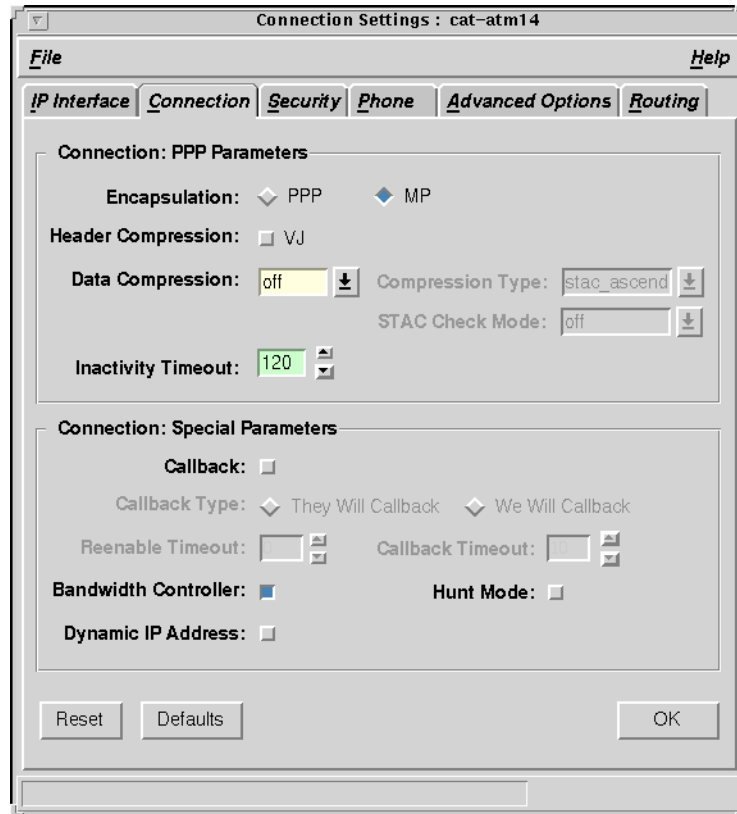

Figure 4-13 PPP Connection Parameters Window

▼ To Configure the Connection Parameters

1. **Click PPP for Point-to-Point Encapsulation (suggested) or MP for Multilink Encapsulation.**  
Multilink Encapsulation complies with RFC 1717.
2. **Click VJ to activate Van Jacobson Header Compression.**  
VJ compression compresses the IP header to three bytes.
3. **Set Data Compression to on to activate data compression.**  
Activating Data Compression allows you to select Compression Type and STAC Check Mode.

- **If you activate Data Compression, select Compression Type.**  
The options are `stac` or `stac_ascend`. Select `stac_ascend` only if you are connecting to an Ascend device, are operating in back-to-back mode, or are connecting to a single B channel.
  - **If you select `stac`, select STAC Check Mode.**  
Select `1cb` for Cisco. Select `sequence3` for Network Express.
- 4. Click Callback if you want to use the callback option.**  
“They will call back” is the Callback Type default.
- **Accept the Reenable Timeout default of 30 seconds or set your preferred time.** See the on-line help for more information about Reenable Timeout.
  - **Accept the Call Back Timeout default of 10 seconds or set your preferred time if you select “We will call back.”** See the on-line help for more information about the Call Back Timeout.
- 5. Click Bandwidth Controller to turn on bandwidth control.**  
To prevent call collisions, only one side should have bandwidth control turned on. The caller typically turns on bandwidth control.
- Hunt Mode is not compatible with Callback or Bandwidth Controller turned on. See the on-line help for more information about Hunt Mode.
- 6. Click Dynamic IP Address only if you are in nomadic mode.**  
See on-line help on Dynamic IP Address or Table 5-3 on page 59 for more information. Select Security to set security parameters.
- The Security Configuration window is displayed (Figure 4-14).

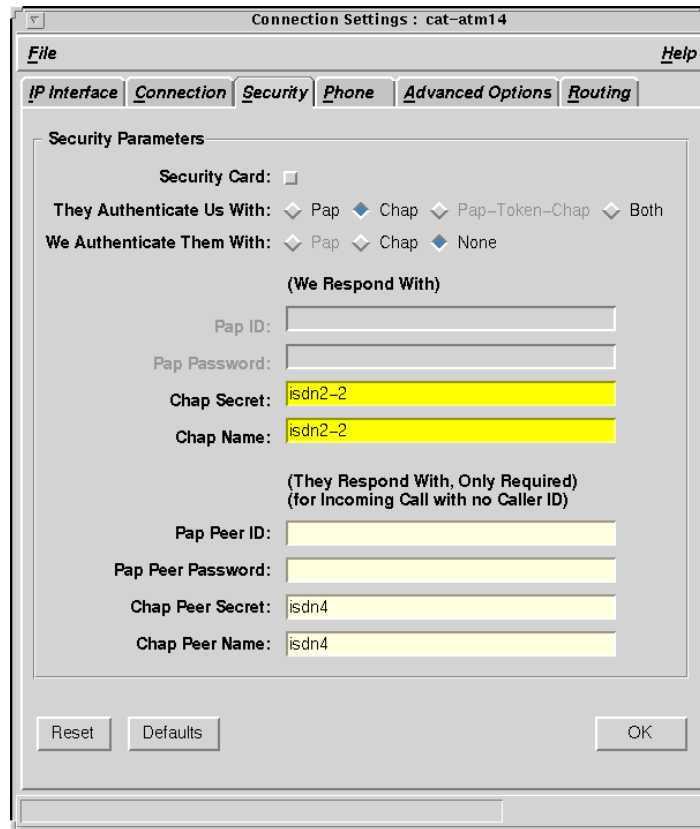

Figure 4-14 PPP Security Configuration Window

▼ To Configure the Security Parameters

1. Click **Security Card** *only* if you are using security card authentication. Security Card applies either to the Enigma DES Gold Card or Security Dynamics SecurID. Use the on-line help or see Table 5-3 on page 59 for detailed information.

Clicking Security Card highlights Pap-Token-Chap authentication. If this is a valid option, all necessary information for this authentication scheme will be given to you by the authenticator.



- 
2. **Click the type of authentication scheme you will use—Pap, Chap, or Both.**  
The fields where you enter information will be activated depending on the type of authentication scheme you selected.
  3. **Type your assigned Pap ID in the Pap ID field or your Chap Secret in the Chap Secret field.**  
Get this information from the remote site.
  4. **Type your assigned password in the Pap Password or your Chap Name in the Chap Name field.**  
Get this information from the remote site.
  5. **Select Phone to configure phone options in the PPP file.**  
The Phone Configuration is displayed (Figure 4-15).

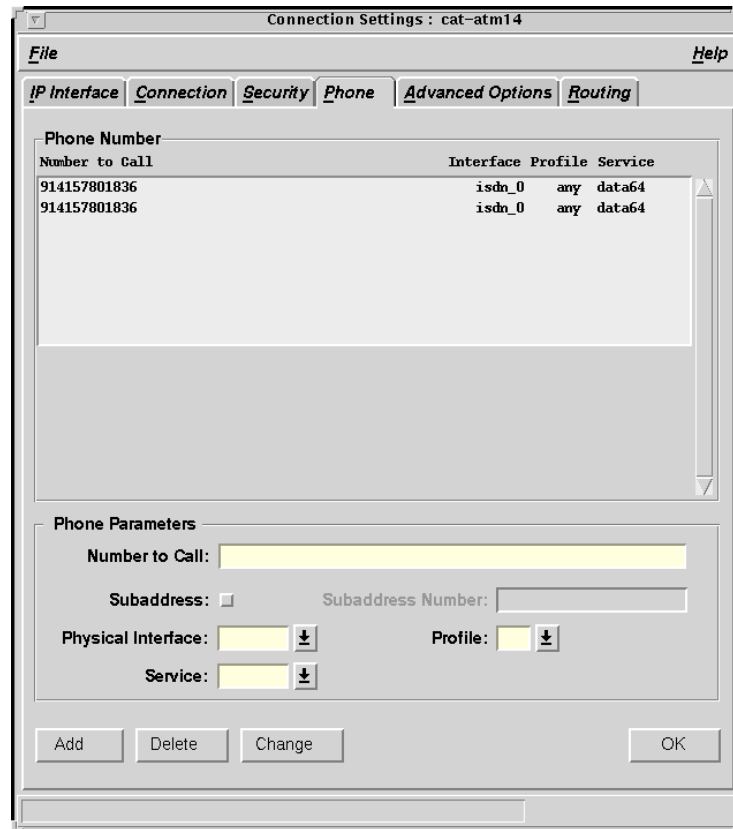

Figure 4-15 PPP Phone Configuration Window

▼ To Configure the Phone Parameters

1. In the Number to Call field, type the phone number of the remote system. Do not insert dashes or spaces.
  - If the number is *within* your area code, type only the local number.
  - If you are calling *outside* your area code, type the access number, area code, and phone number. In the United States, for example, you would type a long distance number in this format: 18005551212.

**2. Click Subaddress only if it is applicable.**

- Type the subaddress if you have one.
  - In Germany, type the EAZ in this field.
- Subaddresses are not used in North America.

**3. Select Physical Interface.**

The options are **isdn\_0**, **isdn\_1** (isdn\_n for as many interfaces as you have), and **any**. Do not select **any** unless all your interfaces are connected to lines. Use on-line help or see Table 5-3 on page 59 for more information.

**4. From the Profile menu, select the profile you want to use.**

The options are A, B, or any.

**5. Choose data64 (preferred) or data56 from the Service menu.**

**6. Click OK to save these parameters to a temporary file.**

**7. Select Advanced Options only under the following conditions:**

- If you are in Japan, you must change Custom Network to `ntt`.
- If you are using MP, set Dynamic Bandwidth Allocation parameters.
- If you are an expert ISDN user, set parameters as you want.

---

**Note** – If Bandwidth Allocation is enabled on either the local or remote host, you *must* configure more than one phone number in the phone folder.

---

The Advanced Options window is displayed (Figure 4-16).

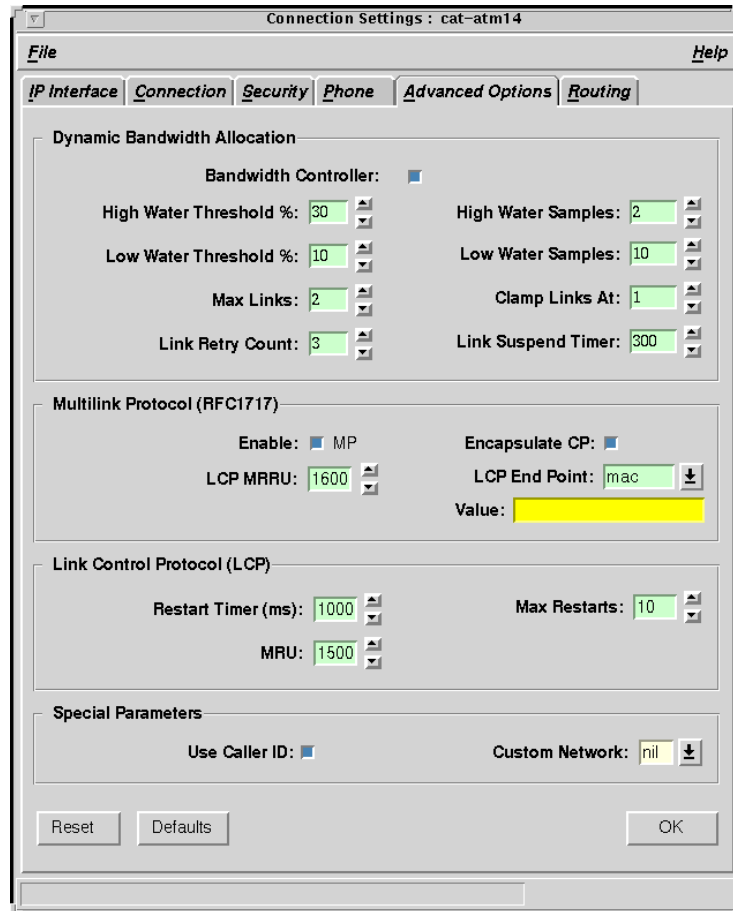

Figure 4-16 Advanced Options Configuration Window

▼ To Configure Advanced Options

1. **Click Bandwidth Controller to enable Dynamic Bandwidth Allocation.** Bandwidth Controller is off by default. Unless you turn it on, all values in the Dynamic Bandwidth Allocation section of this window are inactive. For an explanation of the default settings, see the on-line help or Table 2-2 on page 11.

2. **Click Enable MP to enable Multilink Protocol (RFC 1717).**  
Encapsulate CP is enabled simultaneously. Use the on-line help or see Table 5-3 on page 59 for detailed information.
3. **Accept the LCP End Point default (mac) or select another setting.**  
The options are **mac**, **local**, **ip**, **ppp**, and **psndn**. Use the on-line help or see Table 5-3 on page 59 for detailed information.
4. **Accept the LCP MRRU default (1600) or select another setting.**  
Use the on-line help or see Table 5-3 on page 59 for detailed information.
5. **Accept default settings for LCP parameters unless you have reason to change them.**  
Use the on-line help or see Table 5-3 on page 59 for detailed information.
6. **Click Use Caller ID to enable this parameter.**  
Use the on-line help or see Table 5-3 on page 59 for detailed information.
7. **Change Custom Network to ntt only in Japan.**  
The default setting is acceptable elsewhere.
8. **Select Routing to add route commands.**  
The Routing window is displayed (Figure 4-17).

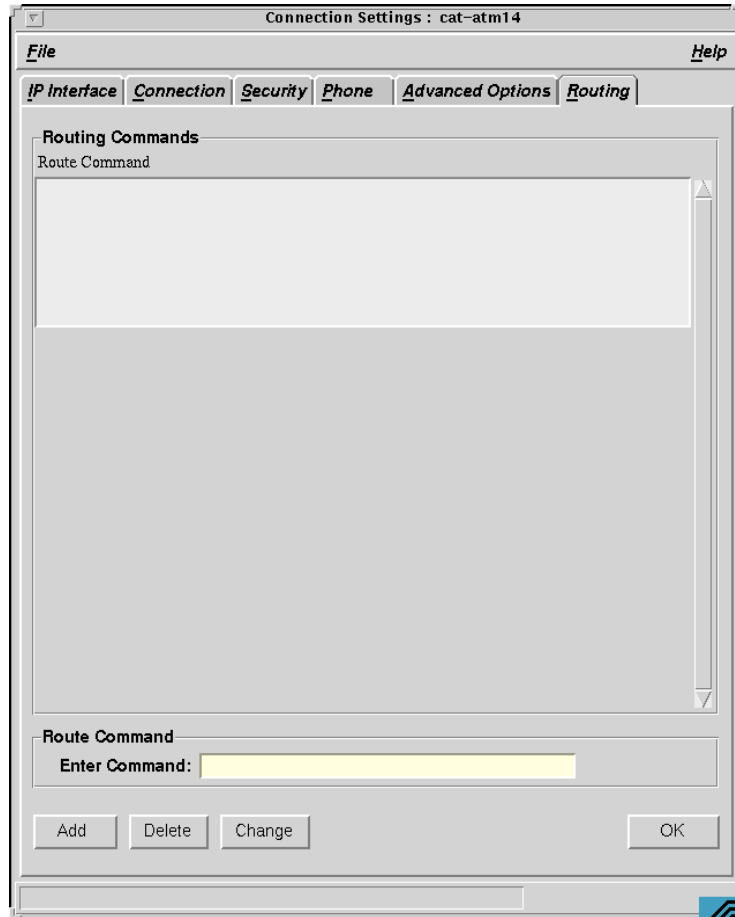

Figure 4-17 PPP Routing Configuration Window

▼ To Configure Routing

1. In the Enter Command field, enter the `route add` command using the following format:

```
route add net destination gateway hop count
```

where:

*net* is an optional parameter used only if the destination is a network.

*destination* is the remote host name or network.

*gateway* is the name of a system that will redirect traffic to the remote host or network, typically the name of your local router.

*hop count* is the number of gateways or routers (hops) required to reach the final destination.

See `man route (1M)` for more details.



**Caution** – The parameters you set for this connection using the connection notebook are not saved to your `isp_ppp.cf` file until you click the OK button in the PPP Configuration Options window (Figure 4-18.)

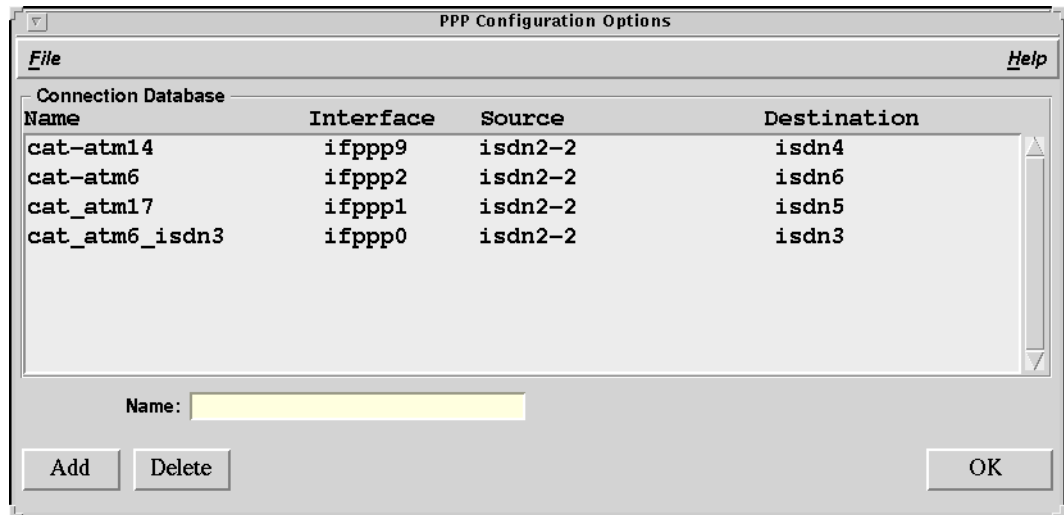

Figure 4-18 PPP Configuration Options Showing Connection Database

2. When you have completed configuring the PPP file, click OK in the PPP Configuration Options window (Figure 4-18) to save your connection parameters to your `/etc/opt/SUNWisdn/SUNWisppp.cf` file. Select Exit from the File menu in the `isdntool` Main window (Figure 4-1).
3. Reboot your machine.

```
# sync
# sync
# sync
# reboot
```

4. Restart both ISDN and PPP after rebooting your system.  
Start `isdntool` again and click Restart. See Step 3 and Step 4 on page 27.

---

**Note** – After you have initially configured the `isdn` or `ppp` configuration files and rebooted your machine, you can make additional changes to the files without rebooting. Just start `isdntool` and click Restart.

---



## *Using a Text Editor to Configure SunISDN 1.0.4*



This chapter shows you how to configure the ISDN configuration files and the point-to-point networking protocol (PPP) configuration files using a text editor. Examples in this chapter show `vi` as the text editor, but instructions are the same regardless of the text editor you use.

The ISDN configuration file contains such information as calling party, phone number, country of origin, and so on. The PPP configuration file identifies the path to the party called, both from a computer system standpoint and the actual phone numbers to be used, as well as the security features to be implemented.

Both ISDN and PPP configuration files are formatted for keyword value entries. Information for these values such as local calling numbers, switch type, service profile ID (SPID), and local and remote IP addresses are provided by your phone company.

### *ISDN Configuration File*

SunISDN 1.0.4 automatically creates ISDN configuration templates under `/etc/opt/SUNWisdn/te` for each ISDN board installed in your system. (`/etc/opt/SUNWisdn/te/0` is the configuration file for the first ISDN board, `/etc/opt/SUNWisdn/te/1` is the file for the second ISDN board, and so on.)

---

**Note** – You must have the information required before proceeding from your phone company as described in Chapter 2, “Before You Begin.”

---

▼ To Configure the ISDN Configuration File

1. **Become superuser.**
2. **Open the ISDN configuration file, using any text editor and press Return.** Be sure to indicate the number of the ISDN device. The following example, using vi, shows the path.

```
# vi /etc/opt/SUNWisdn/te/0
```

The ISDN configuration file is displayed similar to the one shown in Code Example A-1 on page 109. The pound character (#) indicates lines that are not read during configuration execution.

3. **Fill in the keyword values.**  
Each keyword value is shown in angle brackets. See Table 5-1 on page 53 for an explanation of the keywords. For example, replace `>local_nb<` with a local number.
  - a. **Enter the local calling number supplied by your local phone or ISDN provider in the Call Control parameters section.**  
Replace `>calling_number<` with the phone number.
  - b. **In North America, enter the SPID number if supplied by your local phone company.**  
Replace `>spid-0<` with the SPID number.
4. **Repeat the configuration for additional ISDN configuration files te/1, te/2, and so on, if more than one physical device is installed.**
5. **Save and exit the ISDN configuration file.**

## ISDN Configuration File Keywords

Many options have been set during `pkgadd`. Since some parameters are unique to your machine, you must edit this file. All parameters in this configuration file refer only to the local system—your machine.

Table 5-1 lists the ISDN parameters you must edit and their descriptions.

*Table 5-1* ISDN Configuration Parameters

Parameter	Description
<code>cc_config</code>	Identifies the start of the configuration for Call Control (ISDN layer 3).
<code>cc_calling_nb</code> vs. <code>cc_local_nb</code>	The calling number identifies the local system on outgoing calls. The local number filters incoming calls in a multipoint configuration. The local number is required for all multipoint configurations. If connected to a 1TR6 multipoint switch (Germany), you must set <code>cc_local_nb</code> to the EAZ value assigned by your phone company. The EAZ (1-9) is used to differentiate several devices connected to the same multipoint line. EAZ (0) broadcasts an incoming call to all devices. The 1TR6 switch does not forward the complete phone number to the device. It presents only the EAZ number of the number called. EAZ does not apply to 1TR6 point-to-point. Multipoint, NI-1, and NI-2 configurations also require configuring the local address. Set the local address to the <code>cc_calling_nb</code> value.
<code>cc_calling_sub_add</code> vs. <code>cc_local_sub_add</code>	If you are connecting multiple devices to an ISDN line provided by British Telecom ( <code>isdn2</code> ), France Telecom ( <code>vn3</code> or <code>vn6</code> ), or Nippon Telegraph and Telephone (INS-Net64), you can give each ISDN device a unique subaddress that will be used to discriminate between devices with the same ISDN number. The subaddress can be assigned by the phone company where needed, or you may be allowed to make one up. For example, ETSI users are provided a subaddress.

Table 5-1 ISDN Configuration Parameters (Continued)

Parameter	Description
cc_force56	64 Kbps is preferable. If any part of the connection between the local and remote sites is 56 Kbps, then you must set <code>cc_force56</code> to <b>on</b> for incoming calls only.
cc_cli	Set to <b>on</b> only if you are in a country that supports CLI and you subscribe to it. See “Calling Line Identifier (CLI)” on page 17 for more information.
cc_na_country	Country of the <code>calling_nb</code> system. The following are recognized: Australia, Europe, France, Germany, Japan, United Kingdom, and USA.
cc_na_operator	Switch type of the <code>calling_nb</code> system. The graphical user interface uses only the switch type; country or area of origin is assumed from the switch information. You must specify both country and switch type when modifying the configuration file directly. (See Table 4-1 on page 33 for the recognized switch types and their countries.)
ns_config	Identifies the start of network signaling parameters (Q.931)—similar to the call control layer values above except for SPID information.
ns_spid	Differentiates between multiple devices connected to the same multipoint line. Outside North America, make sure <code>ns_spid</code> is commented out by typing the pound sign (#) as the first character in that line.
dl_config	Identifies the start of the data-link parameters (Q.921/LAPD). One section applies to both A and B profiles set in the upper layers. The configurable fields are for North American settings and should not be changed for <code>dms</code> , <code>5ess</code> , and <code>nil</code> switch types. Comment out all other fields.
ph_config	Identifies the start of the physical layer parameters.

## North American Switch Parameters

The remaining data link fields apply to Northern Telecom DMS and AT&T switch types (North America). In North America, use the values supplied in the sample `isdn` configuration file. These values are shown in Table 5-2. Comment all other lines.

Table 5-2 North American Switch Parameters

Data Link Field	Field Value
<code>dl_tei_time_assignment</code>	<code>DL_TEI_TIME_ASSIGN_USA</code>
<code>dl_tei_time_removal</code>	<code>DL_TEI_TIME_REMOVAL_USA</code>
<code>dl_sapi</code>	0
<code>dl_dlcep_nb</code>	3 (Set to 3 for (2) phone numbers and (2) SPIDS.) (Set to 2 for att-ntp or 1 phone number/1 SPID.) (Set to 2 for voice-data line.)
<code>dl_rc_nb</code>	1000
<code>dl_sapi</code>	63
<code>dl_dlcep_nb</code>	3 (Set to 3 for (2) phone numbers and (2) SPIDS.) (Set to 2 for att-ntp or 1 phone number/1 SPID.) (Set to 2 for voice-data line.)
<code>dl_rc_nb</code>	1000

## *PPP Configuration File*

Your PPP configuration file is preconfigured. Since some parameters are unique to your environment, you must edit this file.

---

**Note** – When configuring your PPP configuration file, see Table 5-3 for a description of each parameter.

---

### ▼ To Configure PPP Configuration File

- 1. As superuser, use any text editor to open the PPP configuration file. Enter the path to the `isppp.cf` file and press Return:**

```
# vi /etc/opt/SUNWisdn/isppp.cf
```

The PPP configuration file is displayed similar to the one shown in Code Example A-2 on page 121. The `isppp.cf` file that is displayed on your screen may not include all the explanatory notes shown in this example.

The pound character (#) indicates lines that are not read during configuration execution. These are comment lines.

- 2. Enter the proper settings for your particular environment. They may differ from the preconfigured default settings.**  
See Table 5-3 on page 59 for a description of each parameter.

---

**Note** – Add an `ifconfig` line for every remote machine you call. Repeat the `isdn_path` entry for each user to which you connect.

---

- 3. Exit the PPP configuration file when done.**
- 4. Reboot your system.**

▼ To Start ISDN and PPP Manually

5. After rebooting your system, become superuser and start `isdn` and `isppp`.

```
# cd /opt/SUNWisdn/bin
# ./isdn start
# ./isppp start
```

### *The ifconfig Entry*

The `ifconfig` entry establishes a link between the local address machine and the remote address machine.

```
ifconfig ifppp0 plumb local_address remote_address netmask + private
```

Where:

- `ifppp` is the interface for the `ifconfig` line
- `0` specifies the interface instance `0`.
- `local_address` is your machine name. In Figure 5-1, if your machine is `burke`, then this would be your `local_address`. The machine here is the `remote_address`.

For more information, refer to the `ifconfig` man page.

You must be able to resolve names to IP addresses. The name-to-address translation can be done using the `/etc/hosts` file, or a network name service, such as `yp`, `NIS+`, `DNS`, and so on.

If your system was set up by a system administrator, then the name-to-address resolution method has probably been pre-configured. If you set up your own machine, refer to the *TCP/IP Network Administration Guide* and *Name Services Administration Guide* for additional information.

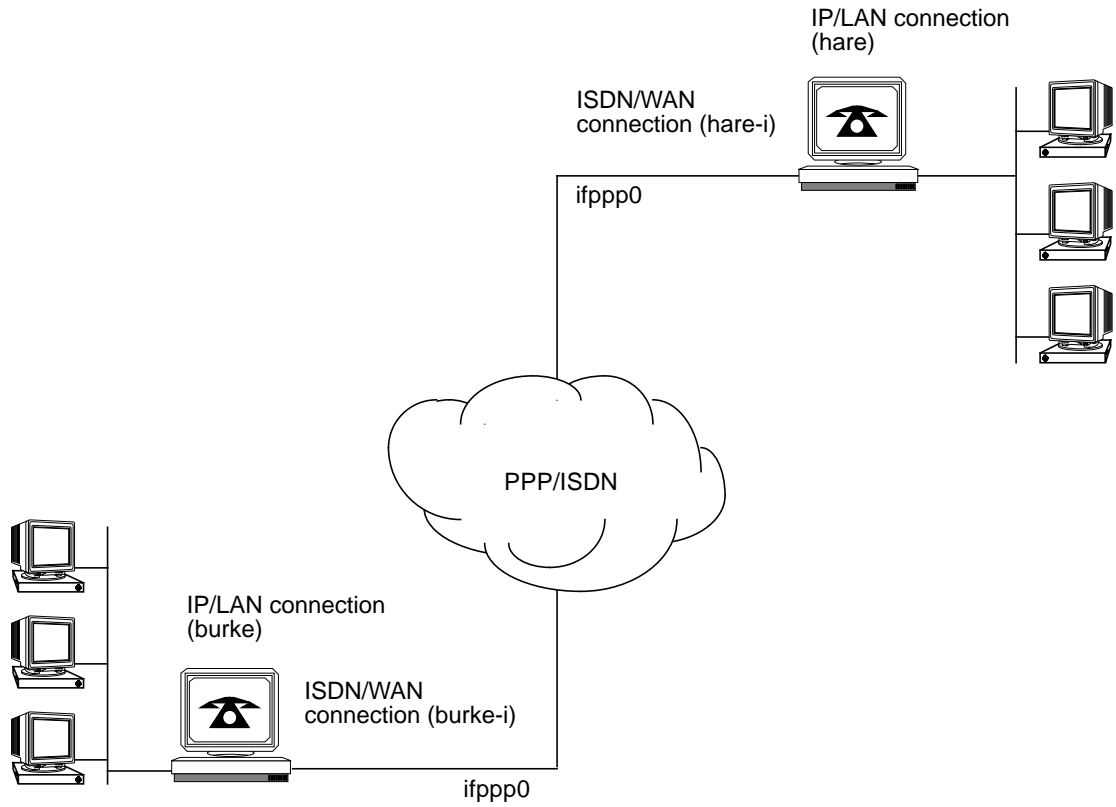

Figure 5-1 SunISDN Point-to-Point Configuration Example



## PPP Configuration File Keywords

Table 5-3 describes each setting keyword in the PPP configuration file.

Table 5-3 Point-to-Point Protocol (PPP) Configuration Keywords

PPP Configuration File Keyword	Description
route	<p>Establishes a static route to a remote gateway. The format is where:</p> <pre>route add net destination gateway hop count</pre> <p><i>net</i> is an optional parameter used only if the destination is a network  <i>destination</i> specifies the remote host name or network  <i>gateway</i> is the name of the system that will redirect traffic to the remote host or network, typically the name of your local router  <i>hop count</i> equals number of hops to gateway  Refer to <code>man route (1M)</code> for more details.</p>
use_caller_id	<p>Applies to all paths mentioned in the PPP configuration file <code>isppp.cf</code>.</p> <p>When <code>use_caller_id</code> is set to <b>on</b>, and <code>caller_id</code> is provided on an incoming call, the PPP manager will use it to find a path.</p> <p>When <code>use_caller_id</code> is set to <b>off</b> or not available, <code>caller_id</code> on an incoming call is ignored. In this case, the PPP manager will rely on PAP or CHAP to find a path. PAP and CHAP parameters must be unique for each path.</p> <p>The default setting is <b>on</b>.</p>
isdn_path	<p>Indicates the start of a path definition section. All parameters following this keyword are associated with this path, until the next occurrence of the <code>isdn_path</code> keyword. No modifier is required, but this must appear as the first line of each new path.</p> <p>Each path entry consists of the information required to identify the destination machine and action/response of the connection. This information is used by the connection manager to modify the IP routing tables and check the identity of the caller.</p> <p>See <code>man ifconfig</code> for more details.</p>

Table 5-3 Point-to-Point Protocol (PPP) Configuration Keywords (Continued)

PPP Configuration File Keyword	Description
name	This arbitrary name is usually the host name of the remote machine but can also be its IP address or any other identifying name.
network	In Japan only, set to ntt. The default is nil.
default_route	Point-to-point only for the duration of the connection makes the route defined by this interface the default route. Refer to man route (1M) for more information.
interface	Must match the second word in the ifconfig command line for point-to-point.
inactivity_timeout	Determines how long (in seconds) that the line can remain inactive before the connection is disconnected. Set the parameter to 0 to create a permanent connection that will not time-out. The default is 120 seconds.
negotiate_address	<p>Supports the concept of a nomadic machine. A system dialing in from a remote office is assigned a temporary IP address (may be associated with that remote office or assigned from a pool of addressees) by the dial-in server. The nomadic machine does not have a permanent IP address. It can move from one remote office to another and is assigned a new IP address associated with the new location. Neither the dial-in server nor the nomadic machine needs to be reconfigured.</p> <p>Restrictions:</p> <p>Enable only on the nomadic system.</p> <p>Enabled when negotiate_address is set to <b>on</b>.</p> <p>Nomadic system must first ping the dial-in server to be assigned an IP address before attempting any ftp, rlogin, telnet, or other tcp service.</p> <p>A bogus address must initially be used on the nomadic system to plumb-up the ifppp interface, for example, ifconfig ifppp0 plumb 0.0.0.0 server up.</p>
Set callback and callback_timeout together on the side calling back, referred to as remote here. Set reenable_timeout on the side that first makes the call, referred to as local here.	
callback	Set to <b>on</b> only if you want the local system to callback. Must be set to on only on one side of the connecting parties. The default is off.

Table 5-3 Point-to-Point Protocol (PPP) Configuration Keywords (Continued)

PPP Configuration File Keyword	Description
callback_timeout	Indicates the amount of time the remote system waits before calling back the local system. The default is 10 seconds.
reenable_timeout	During the reenable_timeout period, the local host will be prevented from placing any further calls, waiting for the callback to complete. reenable_timeout should be large enough to allow enough time for the remote host to complete the callback. Note that this time includes the callback_timeout period. The default is 30 seconds.
called_number <i>dir-number</i> (described below) <i>grouping</i> (described below) <i>interface</i> (described below) <i>profile</i> (described below) <i>service</i> (described below)	Defines one or more called_number lines for each path. If several lines are defined, the PPP manager can set up multiple links to the same destination (see “Dynamic Bandwidth Allocation” on page 11). Separate all subfields by a space.
dir-number	The remote ISDN directory number. When subaddress is required, specify it in the format <i>address, subaddress</i> .
grouping	Always set to 1.
interface	If set to a valid name such as <i>isdn_0, isdn_1, and so on</i> , the ISDN software places a call on this interface name. Use <b>any</b> for automatic interface selection <i>only</i> if all interfaces are connected to a line.
profile	Options are <b>A</b> , <b>B</b> , or <b>any</b> . Multipoint switches (DMS custom, AT&T custom-multipoint, NI-1 or NI-2) can have two profiles configured, each with a different <i>spid</i> and directory number. <b>any</b> enables automatic profile selection. Multiple profiles are used only in North America. Elsewhere use profile A.
service	Options are <b>data56</b> or <b>data64</b> . See “Baud Rate” on page 8. The default is data64.
ipcp_compression	Options are <b>vj</b> or <b>off</b> . Indicates whether IP header compression (Van Jacobson algorithm) is enabled. The default is vj.
ccp	Options are <b>ccp</b> or <b>off</b> . Set to ccp to compress data. The default is off.

Table 5-3 Point-to-Point Protocol (PPP) Configuration Keywords (Continued)

PPP Configuration File Keyword	Description
compression	Options are <b>stac_ascend</b> or <b>stac</b> . Must be set to <b>stac_ascend</b> if you are connecting to an Ascend device, otherwise set to <b>stac</b> .
stac_check_mode	Options are <b>lcb</b> , <b>crc</b> , <b>sequence3</b> . Use <b>lcb</b> for Ascend or Cisco. Use <b>sequence3</b> for Network Express. <b>crc</b> is not implemented by all vendors.
lcp_encapsulation	Set to <b>MP</b> to enable Multilink Protocol (RFC 1717). The default is PPP (Point-to-Point Protocol).
encapsulate_cp	The default is <b>on</b> .
lcp_mru	The maximum size in bytes of received data. The default is 1500.
lcp_mrru	The LCP multilink maximum received reconstructed unit (mrru) option indicates the maximum size message this host can receive after reassembly from all links to this destination. The maximum value is 3000 bytes. The default value for the mrru option is 1600 bytes.
ip_spoofing	<p>Use for placing ISDN calls when the system wants to open connections for broadcast packets over the ISDN/PPP interfaces. Broadcast packets such as routing information packets (RIP) and router discovery packets are currently supported.</p> <p>The default is <b>on</b>. When <b>ip_spoofing</b> is on, the PPP manager will perform call filtering for RIP and router discovery packets so that ISDN calls will not be initiated. When <b>ip_spoofing</b> is off, the PPP manager will place ISDN calls when the system wants to open connections for broadcast packets such as RIP and route discovery packets. Since the interface type of point-to-multipoint is no longer supported, set this field to “on” to disable the broadcast capability if you want the point-to-point interface to behave similarly to a point-to-multipoint interface as supported in the previous releases.</p>

Table 5-3 Point-to-Point Protocol (PPP) Configuration Keywords (Continued)

PPP Configuration File Keyword	Description
lcp_endpoint class value	<p>Options are <b>local</b>, <b>ip</b>, <b>mac</b>, <b>ppp</b>, and <b>psndn</b>.</p> <p><b>local</b> is Class 1 with local address value of 20 bytes maximum length. <b>ip</b> is Class 2 with an ip host address value. <b>mac</b> is Class 3 with a mac address value of 12 bytes. <b>ppp</b> is Class 4 with a value of a block of 1 to 5 concatenated 21 bit PPP magic numbers. <b>psndn</b> is Class 5 with a value that represents an international telephone directory number. The endpoint discriminator option advises a system that the peer on this link could be the same as the peer on another existing link. This option is not required for MP.</p> <p>If you choose to use this option as an additional level of security, you must make sure that the value used is unique network wide. If you are connecting to an Ascend device, you must set this option to <b>mac</b>. <b>mac</b> is the default setting.</p>
security_card	<p>Must be set to <b>on</b> to use Enigma DES Gold Card or Secure Dynamics SecurID authentication.</p>
will_do_authentication	<p>Indicates whether the system will participate in authentication protocol. Options are <b>pap</b>, <b>chap</b>, <b>pap-token-chap</b>, or <b>both</b>. Set <b>pap</b> or <b>chap</b> if the remote system requires authentication.</p> <p>Must be set to <b>pap-token-chap</b> only for Enigma DES Gold card or SecurID authentication. The default is <b>both</b>.</p>

Table 5-3 Point-to-Point Protocol (PPP) Configuration Keywords (Continued)

PPP Configuration File Keyword	Description
require_authentication	<p>Indicates whether the remote peer is required to authenticate itself. Set either <b>pap</b> or <b>chap</b>. Do not mix <b>pap</b> and <b>chap</b> on local and remote machines.</p> <p>The configuration should be symmetrical, that is, both sides should use <b>pap</b> or <b>chap</b>, or neither. When interoperating with SunLink 1.0, use <b>pap</b> on both sides and set <code>require_authentication</code> to <b>pap</b>.</p> <p>If either <b>pap</b> or <b>chap</b> is present, the peer must participate in the authentication protocol or the connection will be terminated. If both <b>pap</b> and <b>chap</b> are present then the system will first try to negotiate <b>chap</b>. If that fails, it will try to negotiate <b>pap</b>. If both fail, the connection will be terminated.</p> <p>If <b>pap</b> is required, then the <code>pap_peer_id</code> and <code>pap_peer_password</code> keywords and values <i>must</i> be specified for the associated path. If <b>chap</b> is required then the <code>chap_peer_name</code> and <code>chap_peer_secret</code> keywords and values <i>must</i> be specified for the associated path.</p> <p>Set to <code>off</code> when connecting to an Ascend device.</p> <p>The default value is <code>off</code>.</p>
pap_id string	<p>One or more characters that represent the authenticated name required by the authenticator to identify this system.</p> <p>Note: To indicate a zero length string, do not include this keyword.</p>
pap_password string	<p>One or more characters that indicate the password for this system.</p> <p>Note: To indicate a zero length string, do not include this keyword.</p>
pap_peer_id string	<p>One or more characters that indicate the name of the peer to be authenticated.</p> <p>Note: To indicate a zero length string, do not include this keyword.</p>
pap_peer_password string	<p>One or more characters used to indicate the password for authentication.</p> <p>Note: To indicate a zero length string, do not include the keyword.</p>

Table 5-3 Point-to-Point Protocol (PPP) Configuration Keywords (Continued)

PPP Configuration File Keyword	Description
chap_secret string	One or more characters, preferably at least 16, that contain the secret that is used with the received challenge value to generate the response sent to the authenticator.
chap_name string	One or more characters representing the identification of this system. The name should not be NUL or CR/LF terminated. The name is sent to the authenticator in a Response packet. The chap_peer_name and chap_name may appear in the received or sent Challenge packets, respectively.
chap_peer_secret string	One or more characters, preferably at least 16, that contain the secret that is used with the challenge value to generate the response received from the peer.
chap_peer_name string	One or more characters representing the identification of the peer transmitting the packet. The name should not be NUL or CR/LF terminated. The name is received from the peer in a Response packet.
bandwidth_controller	Identifies the system controlling the bandwidth. You must <i>not</i> set this to <i>on</i> at both ends of the connection. Typically the caller sets bandwidth_controller.
hiwat hicnt lowat locnt clamp link_retry_count link_suspend_timer	Values used in defining strategies to aggregate B channels. See “Dynamic Bandwidth Allocation” on page 11.
bandwidth	The desired number of aggregated links.
hunt_mode	If <b>on</b> , client will hunt through a list of called_number numbers to reach the remote machine. Default setting is off.
restart_timer	Used when sending an LCP request. Change for tuning requests. Default is 1 second between requests.
max_restarts	The number of LCP requests before terminating the attempt.





This chapter provides troubleshooting information to help you detect and resolve problems with SunISDN network configurations.

## *Common Setup Problems*

Setup conflicts, mismatches, and assumptions are often a source of problems. When checking configuration files, be sure you configured the ISDN and PPP configuration files correctly and have included information for all the required fields. Think about the assumptions that could lead to different configuration errors, such as phone or SPID numbers or passwords. Here are some common problem areas to check:

### ***Determine the Domain Name Service (DNS).***

Name service can be a frequent problem. This can require some assistance if you are not familiar with name service principles. If you do not have a table in `/etc/hosts` or `/etc/resolve.conf` that matches your host name to an IP map address (which looks like 129.146.53.113), find out which DNS server you should connect to and add the name and address to your `/etc/hosts` file. You must establish an IP connection to the server that will provide routing instructions to your computer when you try to connect to remote systems over the network (for example when you use Mosaic). For more information, refer to the *TCP/IP Network Administration Guide* and *Name Services Administration Guide*.

**Determine if you have an ISDN connection before going on to PPP.**

Use trace in the isdntool to look for an RR (receive, ready) message when you start isdntool. Here is the pattern for a healthy ISDN connection:

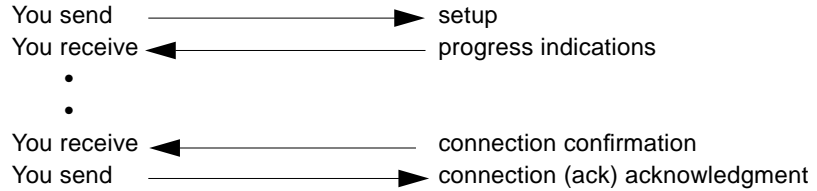

Here is an example of actual traces (calling and called systems):

```

SND on 0 at 16:55:40:0064> INFO      c Sapi=0   Tei=72 p/f=0 n(r)=5   n(s)=4
  SETUP Q931                        Call_reference=1 ORIG
  IE #01: Bc                          88 90
  IE #02: Keypad                       31 34 31 35 38 31 32 39 39 39 39
  IE #03: Calling nb                   c1 33 36 34 39 39 39 39
  IE #04: sending complete
RCV on 0 at 16:55:40:0076> RR      r Sapi=0   Tei=72 p/f=0 n(r)=5

RCV on 0 at 16:55:40:0206> INFO      c Sapi=0   Tei=72 p/f=0 n(r)=5   n(s)=5
  CALL PROC Q931                      Call_reference=1 DEST
  IE #01: Channel id                   89

SND on 0 at 16:55:40:0212> RR      r Sapi=0   Tei=72 p/f=0 n(r)=6
RCV on 0 at 16:55:41:0574> INFO      c Sapi=0   Tei=72 p/f=0 n(r)=5   n(s)=6
  ALERT Q931                           Call_reference=1 DEST
  IE #01: Signal                        01

SND on 0 at 16:55:41:0580> RR      r Sapi=0   Tei=72 p/f=0 n(r)=7

RCV on 0 at 16:55:41:0613> INFO      c Sapi=0   Tei=72 p/f=0 n(r)=5   n(s)=7
  CONNECT Q931                         Call_reference=1 DEST
  IE #01: Signal                        3f

SND on 0 at 16:55:41:0620> RR      r Sapi=0   Tei=72 p/f=0 n(r)=8

SND on 0 at 16:55:41:0658> INFO      c Sapi=0   Tei=72 p/f=0 n(r)=8   n(s)=5
  CONNECT ACKNOWLEDGE Q931             Call_reference=1 ORIG
    
```

*Code Example 6-1* Calling System Trace

```
RCV on 0 at 13:48:07:0176> UI          c Sapi=0   Tei=127 p/f=0
SETUP Q931                             Call_reference=9 ORIG
  IE #01: Bc                            88 90
  IE #02: Channel id                    89
  IE #03: Calling nb                    al 33 36 34 39 39 39 39
  IE #04: Called nb                      c1 34 31 35 38 31 32 39 39 39 39

SND on 0 at 13:48:07:0231> INFO        c Sapi=0   Tei=64 p/f=0
n(r)=92 n(s)=117                       Call_reference=9 DEST
ALERT Q931                              89
  IE #01: Channel id

RCV on 0 at 13:48:07:0238> RR          r Sapi=0   Tei=64 p/f=0
n(r)=118

SND on 0 at 13:48:07:0250> INFO        c Sapi=0   Tei=64 p/f=0
n(r)=92 n(s)=118                       Call_reference=9 DEST
CONNECT Q931

RCV on 0 at 13:48:07:0256> RR          r Sapi=0   Tei=64 p/f=0
n(r)=119

RCV on 0 at 13:48:07:0308> INFO        c Sapi=0   Tei=64 p/f=0
n(r)=119 n(s)=92                       Call_reference=9 ORIG
CONNECT ACKNOWLEDGE Q931                89
  IE #01: Channel id
```

*Code Example 6-2* Called System Trace

***Incorrect Phone Number and SPID***

If you get SETUP messages but you do not respond with ALERT or CONNECT, question the phone number (local in `isdntool` and remote in `isppp.cf`), and the SPID. The SPID may be provided but not needed or vice versa. Try reconfiguring the phone number and the SPID.

```

RCV on 0 at 14:01:50:0605> UI      c Sapi=0   Tei=127 p/f=0
SETUP Q931                        Call_reference=a ORIG
  IE #01: Bc                       88 90
  IE #02: Channel id                89
  IE #03: Calling nb                a1 31 31 30
  IE #04: Called nb                 c1 31 31 31

RCV on 0 at 14:01:54:0649> UI      c Sapi=0   Tei=127 p/f=0
SETUP Q931                        Call_reference=a ORIG
  IE #01: Bc                       88 90
  IE #02: Channel id                89
  IE #03: Calling nb                a1 31 31 30
  IE #04: Called nb                 c1 31 31 31

RCV on 0 at 14:01:59:0649> UI      c Sapi=0   Tei=127 p/f=0
SETUP Q931                        Call_reference=a ORIG
  IE #01: Bc                       88 90
  IE #02: Channel id                89
  IE #03: Calling nb                a1 31 31 30
  IE #04: Called nb                 c1 31 31 31

```

*Code Example 6-3* Called System Trace Shows Neither CONNECT nor ALERT

***You identified either the local number or the remote number with too few or too many digits.***

For example, if you want to connect to a remote site with the same area code, do not use the area code in the `called_number` field of the `isppp.cf` file. Type phone numbers exactly as you would on the phone. Do not use spaces, dashes, or parentheses.

***If you receive a connection acknowledgment but get no reply from the remote, then security issues are the likely problem.***

Check carefully that the password and identification names match correctly in both your file and the remote file with which you want to connect. This must be a mirror image at the two sites. That is your `chap_secret` is the `chap_peer_secret` at the remote site. Their password is the `chap_peer_secret` in your `isppp.cf` file. (This example uses CHAP authentication, but PAP authentication must also be mirrored.) Make sure the `will_do` and `require_authentication` are set properly at both sites.

***Make sure callback is not set to “on” at both the local and remote sites.***

***CLI is set to on but it is not supported between your site and the remote site.***

For example, it is not supported across most network boundaries such as between an ETSI site and an NI-1 site.

***You are trying to run at 64 Kbps but somewhere in the connection that speed is not supported.***

If you are connected to a 64Kbs service, it is possible to receive calls from a remote system connected to a 56Kbs service. However, in this case it may be necessary to enable the `force56` feature.

***Either isdn was not started in isdntool or isppp has not been started.***

***Ask the phone company how you are configured for their switch.***

You might be data/data, voice/voice or voice/data. If you are configured for voice/data, make sure the phone number for data is entered in Profile A.

***Check the active process for ISDN and for PPP.***

A working configuration has both ISDN (`xnet`) and PPP (`ispppd`) running.

Enter the following and press Return after each entry:

```
hostname% ps -ef | grep xnet
(isdn.xnet processes are displayed)
hostname% ps -ef | grep ispppd
(ispppd processes are displayed)
```

***Some DMS switch users (particularly in Canada) may find that they need to use the switch type of ni2.***

In addition, it may be necessary to prepend the remote number in the `isppp.cf` file with an extra digit. For example, you may find that 9 011 333 666 2222 works even though 9 is not part of the normal phone number sequence. Check with your phone company.

***Verify the type of compression configured at both the local and remote sites.***

If data compression is enabled and you have problems communicating with a remote system, compression types may not be configured the same at both the local and remote sites. For example, if compression type is set to `stac` at one site while it is set to `stac_ascend` at the other, you may not be able to connect.

***Check the number of called numbers configured.***

If you cannot get a second B channel to work as multilink protocol connections, you may have only one `called_number` entry in the configuration file `isppp.cf`. To get a second B channel to work, you must have two `called_numbers` configured.

## Getting Help

If you have problems installing or using the SunISDN 1.0.4 software, call your authorized service provider. You must have the following information ready:

- Model number of your machine (for desktop machines, this is on the bottom of the system unit)
- Serial number of the machine (same location as the model number)
- Solaris or SunOS™ release number
- Product release number (1.0.4)

To display your software release level:

◆ **Use the `showrev` command and press Return.**

The display then lists your system's release level. The release level is highlighted in the following example:

```
hostname# showrev
Hostname: rancho
Hostid: 5543734a
Release: 5.5
Kernel architecture: sun4m
Application architecture: sparc
Hardware provider: Sun_Microsystems
Domain: div.mfg.companyB.com
Kernel version: SunOS 5.5 Generic November 1995
```

If you need assistance from SunService, use the TRACE and LOG files to keep track of messages that can be used to determine where the network is failing. The log file is kept permanently but TRACE is a temporary file so any record you want to keep must be copied to a permanent space.

### ▼ To Copy TRACE or LOG Files

1. With the `isdntool` turned on, open both the TRACE and LOG files.
2. Ping the remote site.
3. Copy the TRACE and LOG output to a permanent file that can be sent to the person who supports your site.

## *Using isdntrace*

The command line facility for tracing and recording D-channel activity is called `isdntrace`. You use it to recover the binary information exchanged between the three layers (network layer, data link layer, and physical layer) of the D-channel software. By default, this information is decoded and displayed on the standard output device; however, it can also be saved to a file as either binary or decoded data. Running trace from `isdntool` yields a broad and generalized report. The following sections provides specifics for using `isdntrace`.

<i>Specifying the Input Device</i>	<i>page 75</i>
<i>Recovering the Input from File</i>	<i>page 76</i>
<i>Writing the Output to File</i>	<i>page 77</i>
<i>Modifying the Default Output Format</i>	<i>page 77</i>
<i>Suppressing Time Stamping</i>	<i>page 79</i>
<i>Suppressing the Lost Data Indication</i>	<i>page 80</i>
<i>Using Multiple Command Line Options</i>	<i>page 80</i>

By default, `isdntrace` recovers the binary information exchanged between all three layers of the D-channel software and displays the decoded information on the standard output device in a standard format. You must specify the type of network to which your host is connected.



▼ **To Run isdntrace**

**1. Become superuser.**

You can invoke a general trace from `isdntool` or a more specific trace using a variety of parameters as specified in this section.

Country	Switch Type	Keyword
Australia	AUSTEL	au1
Europe	ETSI	etsi
France	Version Nationale Euro Numeris 3	vn3
France	Version Nationale Euro Numeris 6	vn6
Germany	DBT 1TR6	1tr6
Hong Kong	HKT	hkt
Japan	NTT INS-64	ntt
North America	National ISDN-1 and ISDN-2	ni2
North America	AT&T 5ESS PTP/MTP	5ess
North America	NT DMS100	dms
Sweden	SWD-ETSI	swd-etsi
United Kingdom	BT (ISDN-2)	bt2

**2. Use Table 6-1 to determine the type of network.**

**3. You can only run one instance of isdntrace at a time. To run isdntrace, enter the following and press Return:**

```
# /opt/SUNWisdn/bin/isdntrace -n network_type
```

## *Specifying the Input Device*

Running `isdntrace` with the `-d` option enables you to specify one or more SunISDN devices (physical interfaces) as the source of the binary information. By default, `isdntrace` probes the system and attempts to recover information from all the SunISDN devices that it locates.

- ◆ **To specify the input device, use the index number of its SunOS device name.**

For example, the first SunISDN physical interface installed in a system is assigned the device name of `/dev/isdn/0`. This device is specified by its 0 index.

- ◆ **To specify a single input device, enter the following and press Return:**

```
# /opt/SUNWisdn/bin/isdntrace -n number
```

- ◆ **To specify multiple input devices, enter the following and press Return:**

```
# /opt/SUNWisdn/bin/isdntrace -n network_type -d num1 -d num2
```

### *Recovering the Input from File*

Run `isdntrace` with the `-i` option to specify a file that contains binary information as the input device in place of a SunISDN physical interface. You must create this file before you run `isdntrace` with the `-i` option by running `isdntrace` with the `-b` option. This enables you to write the binary data recovered from one or more SunISDN devices to a file. Note that the `-d` and `-i` options are mutually exclusive.

```
# /opt/SUNWisdn/bin/isdntrace -n network_type -i filename
```

The `-f` option can be used in conjunction with the `-i` option. You use it to direct `isdntrace` to read past the end of the specified input file.

```
# /opt/SUNWisdn/bin/isdntrace -n network_type -i input_file -f
```

## Writing the Output to File

Running `isdntrace` with the `-o` option enables you to write the decoded data to a specified output file. The information is recorded in the same format as it would have been displayed on the standard output device. The information is written to a file only and it is not displayed on the standard output device.

```
# /opt/SUNWisdn/bin/isdntrace -n network_type -o output_file
```

Running `isdntrace` with the `-b` option enables you to write (raw) binary data to a specified output file. This output file can be used later as the input to `isdntrace` using the `-i` option. By default, the information is written to file only; it is not displayed on the standard output device.

```
# /opt/SUNWisdn/bin/isdntrace -n network_type -b raw_output_file
```

The `-s` option can be used in conjunction with the `-b` option. You use it to display decoded data on the standard output device at the same time as binary data is written to file.

```
# /opt/SUNWisdn/bin/isdntrace -n network_type -b raw_output_file -s
```

## Modifying the Default Output Format

By default, the `isdntrace` always displays the decoded layer one (physical layer) information. Running `isdntrace` with the `-1` option suppresses the layer 1 information entirely.

```
# /opt/SUNWisdn/bin/isdntrace -n network_type -1
```

By default, `isdntrace` always displays the decoded layer 2 (data link layer) information together with details of the TEI management. Run `isdntrace` with the `-2` option to modify the information displayed.

▼ To Modify the Default Output Format

- Use the `off` modifier to suppress the layer 2 information entirely.

```
# /opt/SUNWisdn/bin/isdntrace -n <network_type> -2 off
```

- Use the `hex` modifier to display the hexadecimal equivalent of the layer 2 information:

```
# /opt/SUNWisdn/bin/isdntrace -n network_type -2 hex
```

- Use the `basic` modifier to display the decoded layer 2 information:

```
# /opt/SUNWisdn/bin/isdntrace -n network_type -2 basic
```

- Use the `detail` modifier to display the decoded layer 2 information together with details of the TEI (Terminal Endpoint Identifier) management (default).

```
# /opt/SUNWisdn/bin/isdntrace -n network_type -detail
```

By default, `isdntrace` always displays the decoded layer 3 (network layer) messages and Information Elements (IEs) together with the hex equivalent of the information it contains. Running `isdntrace` with the `-3` option can be used to modify the information displayed.

- Use the `off` modifier to suppress the layer 3 information entirely:

```
# /opt/SUNWisdn/bin/isdntrace -n network_type -3 off
```

- Use the `hex` modifier to display the hexadecimal equivalent of the layer 3 information:

```
# /opt/SUNWisdn/bin/isdntrace -n network_type -3 hex
```

- Use the `ascii` modifier to display the `ascii` (printable character) equivalent of the layer 3 information:

```
# /opt/SUNWisdn/bin/isdntrace -n network_type -3 ascii
```

- Use the `hdr` modifier to display the layer 3 header information only:

```
# /opt/SUNWisdn/bin/isdntrace -n network_type -3 hdr
```

- Use the `ie_hex` modifier to display the decoded name of the layer 3 Information Element (IE) together with the hexadecimal equivalent of the information it contains (default display):

```
# /opt/SUNWisdn/bin/isdntrace -n network_type -3 ie_hex
```

- Use the `ie_ascii` modifier to display the decoded name of the layer 3 Information Element (IE) together with the `ascii` (printable character) equivalent of the information it contains:

```
# /opt/SUNWisdn/bin/isdntrace -n <network_type> -3 ie_ascii
```

## *Suppressing Time Stamping*

By default, the decoded information is displayed with time stamping, which indicates the date and time at which the information was recovered. Use the `-t` option to turn off date and time stamping:

```
# /opt/SUNWisdn/bin/isdntrace -n network_type -t
```

## Suppressing the Lost Data Indication

By default, `isdntrace` logs each time data is lost. Use the `-l` option to turn off the lost data indicator:

```
# /opt/SUNWisdn/bin/isdntrace -n network_type -l
```

## Using Multiple Command Line Options

The command line options can be concatenated to tailor the effects of `isdntrace`. Note that the `-d` and `-i` options are mutually exclusive.

For example,

- To capture the input from the second SunISDN device installed in a host system connected to the ISDN service from one of the carriers in the United States and to write only the layer 2 and layer 3 decoded information to file:

```
# /opt/SUNWisdn/bin/isdntrace -n 5ess -d 2 -o output_file -2 hex
```

- To recover the input from a binary output file (created earlier using the `-b` option) containing the information from a SunISDN device attached to the ISDN service offered by France Telecom and to display the hexadecimal equivalent of the layer 2 and layer 3 information only on the standard output device:

```
# /opt/SUNWisdn/bin/isdntrace -n vn6 -i input_file -l off -2 ascii -3 ie_ascii
```

## Interpreting the Output from `isdntrace`

The D-channel information that is recovered using `isdntrace` is carrier-dependent. When interpreting the decoded information you will need to refer to the relevant carrier-dependent interface specification. The following example traces were taken from a system connected to the ISDN through an interface conforming to the AT&T 5ESS 5e5 specifications. They are the result of a single successful `ping` generated by the local system.

### Example Trace 1: Default Options

This example trace was taken on a system attached directly to the ISDN through an interface conforming to the AT&T 5ESS 5e5 specification, using the default command-line options:

```
# /opt/SUNWisdn/bin/isdntrace -n 5ess
```

Layer 1 deactivated

```
RCV on 1 at 18:51:12:0146> MANAGEMENT DISCONNECT INDICATION
RCV on 1 at 18:51:12:0148> MANAGEMENT DEACTIVATION INDICATION
RCV on 1 at 18:51:12:0148> PHYSICAL DEACTIVATION INDICATION
```

Layer 1 activated

```
RCV on 1 at 18:51:12:0171> PHYSICAL ACTIVATION INDICATION
RCV on 1 at 18:51:12:0171> MANAGEMENT ACTIVATION INDICATION
RCV on 1 at 18:51:12:0171> MANAGEMENT ERROR 2 INDICATION
```

Connection begins to be established. Local system generates SETUP message

```
SND on 1 at 18:51:21:0222> UI          c Sapi=63 Tei=127 p/f=0
TEI Mngt: Identity Request      Ai=127 Ri=32495
```

```
RCV on 1 at 18:51:21:0239> UI          c Sapi=63 Tei=127 p/f=0
TEI Mngt: Identity Assigned     Ai=80 Ri=32495
```

```
SND on 1 at 18:51:21:0250> SABME      c Sapi=0   Tei=80 p/f=1
```

```
RCV on 1 at 18:51:21:0263> UA        r Sapi=0   Tei=80 p/f=1
```

Called and calling addresses can be decoded from the information elements

```
SND on 1 at 18:51:21:0292> INFO      c Sapi=0   Tei=80 p/f=0 n(r)=0  n(s)=0
SETUP Q931                      Call_reference=2 ORIG
IE #01: Bc                        88 90
IE #02: Keypad                    31 32 33 34 35 36 37 38
IE #03: Calling nb.               c1 38 37 36 35 34 33 32 31
```

```
RCV on 1 at 18:51:21:0307> RR        r Sapi=0   Tei=80 p/f=0 n(r)=1
```

ISDN exchange acknowledges connection attempt and returns encoded Channel Id indicating channel B1 or B2.

```
RCV on 1 at 18:51:21:0513> INFO      c Sapi=0   Tei=80 p/f=0 n(r)=1  n(s)=0
CALL PROC Q931                   Call_reference=2 DEST
IE #01: Channel id.              89
```

Management information returned by the ISDN exchange (or PABX)

```
SND on 1 at 18:51:21:0529> RR          r Sapi=0   Tei=80 p/f=0 n(r)=1
RCV on 1 at 18:51:21:0779> INFO      c Sapi=0   Tei=80 p/f=0 n(r)=1  n(s)=1
INFO Q931                             Call_reference=0 ORIG
  IE #01: Codeset 6
  IE #02: Sel. call appear.           01
  IE #03: Keypad control               01
  IE #04: Feature ind.                 81 0a 01
  IE #05: Display cont.                10
```

Remote system acknowledges connection

```
SND on 1 at 18:51:21:0797> RR          r Sapi=0   Tei=80 p/f=0 n(r)=2
RCV on 1 at 18:51:21:0989> INFO      c Sapi=0   Tei=80 p/f=0 n(r)=1  n(s)=2
CONNECT Q931                           Call_reference=2 DEST
```

End of connection establishment

```
SND on 1 at 18:51:22:0059> RR          r Sapi=0   Tei=80 p/f=0 n(r)=3
SND on 1 at 18:51:22:0153> INFO      c Sapi=0   Tei=80 p/f=0 n(r)=3  n(s)=1
CONNECT ACKNOWLEDGE Q931              Call_reference=2 ORIG
```

```
RCV on 1 at 18:51:22:0167> RR          r Sapi=0   Tei=80 p/f=0 n(r)=2
```

```
RCV on 1 at 18:51:52:0294> RR          c Sapi=0   Tei=80 p/f=1 n(r)=2
```

```
SND on 1 at 18:51:52:0304> RR          r Sapi=0   Tei=80 p/f=1 n(r)=3
```

Start of call disconnect

In this example, both systems initiate a disconnect at the same time. This represents a "clear collision."

```
RCV on 1 at 18:51:53:0088> INFO      c Sapi=0   Tei=80 p/f=0 n(r)=2  n(s)=3
DISCONNECT Q931                        Call_reference=2 DEST
  IE #01: Cause                          80 90
```

```
SND on 1 at 18:51:53:0114> INFO      c Sapi=0   Tei=80 p/f=0 n(r)=3  n(s)=2
DISCONNECT Q931                        Call_reference=2 ORIG
  IE #01: Cause                          80 90
```

```
SND on 1 at 18:51:53:0118> RR          r Sapi=0   Tei=80 p/f=0 n(r)=4
```

```
RCV on 1 at 18:51:53:0128> RR          r Sapi=0   Tei=80 p/f=0 n(r)=3
```

ISDN exchange (or PABX) acknowledges disconnect

```
RCV on 1 at 18:51:53:0324> INFO      c Sapi=0   Tei=80 p/f=0 n(r)=3  n(s)=4
RELEASE Q931                            Call_reference=2 DEST
```

Local system acknowledges disconnect; call cleared successfully

```
SND on 1 at 18:51:53:0338> RR          r Sapi=0   Tei=80 p/f=0 n(r)=5
```

```
SND on 1 at 18:51:53:0344> INFO      c Sapi=0   Tei=80 p/f=0 n(r)=5  n(s)=3
RELEASE COMPLETE Q931                  Call_reference=2 ORIG
```

End of call disconnect



Layer 1 deactivated by  
disconnecting the ISDN line  
from the system

```
RCV on 1 at 18:51:53:0358> RR          r Sapi=0   Tei=80 p/f=0 n(r)=4
RCV on 1 at 18:52:09:0880> MANAGEMENT DEACTIVATION INDICATION
RCV on 1 at 18:52:09:0880> PHYSICAL DEACTIVATION INDICATION
```

### *Example Trace 2: Layer 1 Information Suppressed*

This example trace was taken on a system attached directly to the ISDN through an interface conforming to the AT&T 5ESS 5e5 specification, using the following command-line options:

```
# /opt/SUNWisdn/bin/isdntrace -n 5ess -1
```

This trace is almost identical to the previous example; however, there is no record of the layer 1 activation/deactivation caused by connecting and disconnecting the ISDN line.

Start of connection establishment procedure. Local system generates SETUP message

Called and calling addresses can be decoded from the information elements

ISDN exchange acknowledges connection attempt and returns encoded Channel Id indicating channel B1 or B2

Management information returned by the ISDN exchange (or PABX)

```

SND on 1 at 18:51:21:0222> UI          c Sapi=63 Tei=127 p/f=0
  TEI Mngt: Identity Request          Ai=127 Ri=32495

RCV on 1 at 18:51:21:0239> UI          c Sapi=63 Tei=127 p/f=0
  TEI Mngt: Identity Assigned         Ai=80 Ri=32495

SND on 1 at 18:51:21:0250> SABME       c Sapi=0   Tei=80 p/f=1

RCV on 1 at 18:51:21:0263> UA          r Sapi=0   Tei=80 p/f=1

SND on 1 at 18:51:21:0292> INFO        c Sapi=0   Tei=80 p/f=0 n(r)=0  n(s)=0
  SETUP Q931                          Call_reference=2 ORIG
  IE #01: Bc                            88 90
  IE #02: Keypad                        31 32 33 34 35 36 37 38
  IE #03: Calling nb.                   c1 38 37 36 35 34 33 32 31

RCV on 1 at 18:51:21:0307> RR          r Sapi=0   Tei=80 p/f=0 n(r)=1

RCV on 1 at 18:51:21:0513> INFO        c Sapi=0   Tei=80 p/f=0 n(r)=1  n(s)=0
  CALL PROC Q931                       Call_reference=2 DEST
  IE #01: Channel id.                   89

SND on 1 at 18:51:21:0529> RR          r Sapi=0   Tei=80 p/f=0 n(r)=1

RCV on 1 at 18:51:21:0779> INFO        c Sapi=0   Tei=80 p/f=0 n(r)=1  n(s)=1
  INFO Q931                             Call_reference=0 ORIG
  IE #01: Codeset 6                     01
  IE #02: Sel. call appear.              01
  IE #03: Keypad control                  01
  IE #04: Feature ind.                   81 0a 01
  IE #05: Display cont.                   10

```

Remote system acknowledges connection	SND on 1 at 18:51:21:0797> RR	r Sapi=0 Tei=80 p/f=0 n(r)=2
	RCV on 1 at 18:51:21:0989> INFO CONNECT Q931	c Sapi=0 Tei=80 p/f=0 n(r)=1 n(s)=2 Call_reference=2 DEST
End of connection establishment	SND on 1 at 18:51:22:0059> RR	r Sapi=0 Tei=80 p/f=0 n(r)=3
	SND on 1 at 18:51:22:0153> INFO CONNECT ACKNOWLEDGE Q931	c Sapi=0 Tei=80 p/f=0 n(r)=3 n(s)=1 Call_reference=2 ORIG
	RCV on 1 at 18:51:22:0167> RR	r Sapi=0 Tei=80 p/f=0 n(r)=2
	RCV on 1 at 18:51:52:0294> RR	c Sapi=0 Tei=80 p/f=1 n(r)=2
	SND on 1 at 18:51:52:0304> RR	r Sapi=0 Tei=80 p/f=1 n(r)=3
Start of call disconnect	RCV on 1 at 18:51:53:0088> INFO DISCONNECT Q931 IE #01: Cause	c Sapi=0 Tei=80 p/f=0 n(r)=2 n(s)=3 Call_reference=2 DEST 80 90
In this example, both systems initiate a disconnect at the same time. This represents a "clear collision."	SND on 1 at 18:51:53:0114> INFO DISCONNECT Q931 IE #01: Cause	c Sapi=0 Tei=80 p/f=0 n(r)=3 n(s)=2 Call_reference=2 ORIG 80 90
	SND on 1 at 18:51:53:0118> RR	r Sapi=0 Tei=80 p/f=0 n(r)=4
	RCV on 1 at 18:51:53:0128> RR	r Sapi=0 Tei=80 p/f=0 n(r)=3
ISDN exchange (or PABX) acknowledges disconnect	RCV on 1 at 18:51:53:0324> INFO RELEASE Q931	c Sapi=0 Tei=80 p/f=0 n(r)=3 n(s)=4 Call_reference=2 DEST
Local system acknowledges disconnect; call cleared successfully	SND on 1 at 18:51:53:0338> RR	r Sapi=0 Tei=80 p/f=0 n(r)=5
	SND on 1 at 18:51:53:0344> INFO RELEASE COMPLETE Q931	c Sapi=0 Tei=80 p/f=0 n(r)=5 n(s)=3 Call_reference=2 ORIG
End of call disconnect	RCV on 1 at 18:51:53:0358> RR	r Sapi=0 Tei=80 p/f=0 n(r)=4

### ***Example Trace 3: Layer 1 and Layer 2 Information Suppressed***

This example trace was taken on a system attached directly to the ISDN through an interface conforming to the AT&T 5ESS 5e5 specification, using the following command-line options:

```
# /opt/SUNWisdn/bin/isdntrace -n 5ess -1 -2 off
```

Start of connection establishment procedure. Local system generates SETUP message

Called and calling addresses are decoded and displayed

ISDN exchange acknowledges connection attempt and returns encoded Channel Id indicating channel B1 or B2

Management information returned by the ISDN exchange (or PABX)

Remote system acknowledges connection  
End of connection establishment procedure

Start of call disconnect procedure

```

SND on 1 at 18:51:21:0292>   SETUP Q931                Call_reference=2 ORIG
    IE #01: Bc                88 90
    IE #02: Keypad            31 32 33 34 35 36 37 38
    IE #03: Calling nb.       c1 38 37 36 35 34 33 32 31

RCV on 1 at 18:51:21:0513>   CALL PROC Q931           Call_reference=2 DEST
    IE #01: Channel id.       89

RCV on 1 at 18:51:21:0779>   INFO Q931                Call_reference=0 ORIG
    IE #01: Codeset 6
    IE #02: Sel. call appear. 01
    IE #03: Keypad control    01
    IE #04: Feature ind.      81 0a 01
    IE #05: Display cont.     10

RCV on 1 at 18:51:21:0989>   CONNECT Q931           Call_reference=2 DEST

SND on 1 at 18:51:22:0153>   CONNECT ACKNOWLEDGE Q931 Call_reference=2 ORIG

RCV on 1 at 18:51:53:0088>   DISCONNECT Q931        Call_reference=2 DEST
    IE #01: Cause             80 90

SND on 1 at 18:51:53:0114>   DISCONNECT Q931        Call_reference=2 ORIG
    IE #01: Cause             80 90

RCV on 1 at 18:51:53:0324>   RELEASE Q931           Call_reference=2 DEST

SND on 1 at 18:51:53:0344>   RELEASE COMPLETE Q931 Call_reference=2 ORIG
    
```

### *Example Trace 4: Layer 3 Information Expressed in ASCII*

This example trace was taken on a system attached directly to the ISDN through an interface conforming to the AT&T 5ESS 5e5 specification, using the following command-line options:

```
# /opt/SUNWisdn/bin/isdntrace -n 5ess -1 -2 off -3 ascii -l
```

Start of connection establishment procedure. Local system generates SETUP message

Called and calling addresses contained in the information elements are decoded and displayed

```

SND on 1 at 18:51:21:0292>   Ns msg size : 23
  Ns msg :
  .....12345678..87654321

RCV on 1 at 18:51:21:0513>   Ns msg size : 7
  Ns msg :
  .....

RCV on 1 at 18:51:21:0779>   Ns msg size : 18
  Ns msg :
  ..{."..2..9....;...

RCV on 1 at 18:51:21:0989>   Ns msg size : 4
  Ns msg :
  ....

SND on 1 at 18:51:22:0153>   Ns msg size : 4
  Ns msg :
  ....

RCV on 1 at 18:51:53:0088>   Ns msg size : 8
  Ns msg :
  ...E....

SND on 1 at 18:51:53:0114>   Ns msg size : 8
  Ns msg :
  ...E....

RCV on 1 at 18:51:53:0324>   Ns msg size : 4
  Ns msg :
  ...M

SND on 1 at 18:51:53:0344>   Ns msg size : 4
  Ns msg :
  ...Z

```

### *Example Trace 5: Layer 3 Header Only*

This example trace was taken on a system attached directly to the ISDN through an interface conforming to the AT&T 5ESS 5e5 specification, using the following command-line options:

```
# /opt/SUNWisdn/bin/isdntrace -n 5ess -1 -2 off -3 hdr
```

Start of connection establishment procedure. Local system generates SETUP message

Header information shows progress of the call

SND on 1 at 18:51:21:0292>	SETUP Q931	Call_reference=2 ORIG
RCV on 1 at 18:51:21:0513>	CALL PROC Q931	Call_reference=2 DEST
RCV on 1 at 18:51:21:0779>	INFO Q931	Call_reference=0 ORIG
RCV on 1 at 18:51:21:0989>	CONNECT Q931	Call_reference=2 DEST
SND on 1 at 18:51:22:0153>	CONNECT ACKNOWLEDGE Q931	Call_reference=2 ORIG
RCV on 1 at 18:51:53:0088>	DISCONNECT Q931	Call_reference=2 DEST
SND on 1 at 18:51:53:0114>	DISCONNECT Q931	Call_reference=2 ORIG
RCV on 1 at 18:51:53:0324>	RELEASE Q931	Call_reference=2 DEST
SND on 1 at 18:51:53:0344>	RELEASE COMPLETE Q931	Call_reference=2 ORIG

***Example Trace 6: Layer 3 Information Element (ASCII)***

This example trace was taken on a system attached directly to the ISDN through an interface conforming to the AT&T 5ESS 5e5 specification, using the following command-line options:

```
# /opt/SUNWisdn/bin/isdntrace -n 5ess -1 -2 off -3 ie_ascii
```

Start of connection establishment procedure. Local system generates SETUP message.

Called and calling addresses in the information elements are decoded and displayed

```

SND on 1 at 18:51:21:0292>   SETUP Q931           Call_reference=2 ORIG
    IE #01: Bc                ..
    IE #02: Keypad            12345678
    IE #03: Calling nb.      .87654321

RCV on 1 at 18:51:21:0513>   CALL PROC Q931        Call_reference=2 DEST
    IE #01: Channel id.      .

RCV on 1 at 18:51:21:0779>   INFO Q931           Call_reference=0 ORIG
    IE #01: Codeset 6
    IE #02: Sel. call appear. .
    IE #03: Keypad control   .
    IE #04: Feature ind.     ...
    IE #05: Display cont.    .

RCV on 1 at 18:51:21:0989>   CONNECT Q931         Call_reference=2 DEST

SND on 1 at 18:51:22:0153>   CONNECT ACKNOWLEDGE Q931 Call_reference=2 ORIG

RCV on 1 at 18:51:53:0088>   DISCONNECT Q931       Call_reference=2 DEST
    IE #01: Cause            ..

SND on 1 at 18:51:53:0114>   DISCONNECT Q931       Call_reference=2 ORIG
    IE #01: Cause            ..

RCV on 1 at 18:51:53:0324>   RELEASE Q931          Call_reference=2 DEST

SND on 1 at 18:51:53:0344>   RELEASE COMPLETE Q931 Call_reference=2 ORIG

```

### *Example Trace 7: Time Stamping Suppressed*

This example trace was taken on a system attached directly to the ISDN through an interface conforming to the AT&T 5ESS 5e5 specification, using the default command-line options:

```
# /opt/SUNWisdn/bin/isdntrace -n 5ess -l -t
```

Start of connection establishment procedure. Local system generates SETUP message

Called and calling addresses can be decoded from the information elements

ISDN exchange acknowledges connection attempt and returns encoded Channel Id indicating channel B1 or B2

Management information returned by the ISDN exchange (or PABX)

SND on 1> UI TEI Mngt: Identity Request	c Sapi=63 Tei=127 p/f=0 Ai=127 Ri=32495
RCV on 1> UI TEI Mngt: Identity Assigned	c Sapi=63 Tei=127 p/f=0 Ai=80 Ri=32495
SND on 1> SABME	c Sapi=0 Tei=80 p/f=1
RCV on 1> UA	r Sapi=0 Tei=80 p/f=1
SND on 1> INFO SETUP Q931 IE #01: Bc IE #02: Keypad IE #03: Calling nb.	c Sapi=0 Tei=80 p/f=0 n(r)=0 n(s)=0 Call_reference=2 ORIG 88 90 31 32 33 34 35 36 37 38 c1 38 37 36 35 34 33 32 31
RCV on 1> RR	r Sapi=0 Tei=80 p/f=0 n(r)=1
RCV on 1> INFO CALL PROC Q931 IE #01: Channel id.	c Sapi=0 Tei=80 p/f=0 n(r)=1 n(s)=0 Call_reference=2 DEST 89
SND on 1> RR	r Sapi=0 Tei=80 p/f=0 n(r)=1
RCV on 1> INFO INFO Q931 IE #01: Codeset 6 IE #02: Sel. call appear. IE #03: Keypad control IE #04: Feature ind. IE #05: Display cont.	c Sapi=0 Tei=80 p/f=0 n(r)=1 n(s)=1 Call_reference=0 ORIG 01 01 81 0a 01 10
SND on 1> RR	r Sapi=0 Tei=80 p/f=0 n(r)=2

### *Example Trace 8: Lost Data Indication Suppressed*

The following example traces were taken on a system attached directly to the ISDN through an interface conforming to the AT&T 5ESS 5e5 specification. Errors were introduced into the system to illustrate how `isdntrace` indicates its inability to recover data from the D-channel.



The first trace includes indication of the lost data (default) and was generated using the following command-line options:

```
# /opt/SUNWisdn/bin/isdntrace -n 5ess -1 -2 off
```

```
RCV on 1 at 18:51:13:0033> SETUP Q931 Call_reference=7f DEST
  IE #01: Bc 80 90 a2
  IE #02: Channel id. 88
  IE #03: Codeset 6
  IE #04: Des. call appear. 01

WARNING ! 51989 outgoing frames were lost.
WARNING ! 52012 incoming frames were lost.

SND on 1 at 18:51:21:0292> SETUP Q931 Call_reference=2 ORIG
  IE #01: Bc 88 90
  IE #02: Keypad 31 32 33 34 35 36 37 38
  IE #03: Calling nb. c1 38 37 36 35 34 33 32 31

RCV on 1 at 18:51:21:0513> CALL PROC Q931 Call_reference=2 DEST
  IE #01: Channel id. 89

RCV on 1 at 18:51:21:0779> INFO Q931 Call_reference=0 ORIG
  IE #01: Codeset 6
  IE #02: Sel. call appear. 01
  IE #03: Keypad control 01
  IE #04: Feature ind. 81 0a 01
  IE #05: Display cont. 10

RCV on 1 at 18:51:21:0989> CONNECT Q931 Call_reference=2 DEST

SND on 1 at 18:51:22:0153> CONNECT ACKNOWLEDGE Q931 Call_reference=2 ORIG

WARNING ! 51984 outgoing frames were lost.
WARNING ! 52007 incoming frames were lost.
```

The second trace suppresses the lost data indication and was generated using the following command-line options:

```
# /opt/SUNWisdn/bin/isdntrace -n 5ess -1 -2 off -l -2 off -l
```

```

RCV on 1 at 18:51:13:0033>   SETUP Q931           Call_reference=7f DEST
    IE #01: Bc                 80 90 a2
    IE #02: Channel id.        88
    IE #03: Codeset 6
    IE #04: Des. call appear.  01

SND on 1 at 18:51:21:0292>   SETUP Q931           Call_reference=2 ORIG
    IE #01: Bc                 88 90
    IE #02: Keypad             31 32 33 34 35 36 37 38
    IE #03: Calling nb.       c1 38 37 36 35 34 33 32 31

RCV on 1 at 18:51:21:0513>   CALL PROC Q931        Call_reference=2 DEST
    IE #01: Channel id.        89

RCV on 1 at 18:51:21:0779>   INFO Q931           Call_reference=0 ORIG
    IE #01: Codeset 6
    IE #02: Sel. call appear.  01
    IE #03: Keypad control     01
    IE #04: Feature ind.       81 0a 01
    IE #05: Display cont.     10

RCV on 1 at 18:51:21:0989>   CONNECT Q931         Call_reference=2 DEST

SND on 1 at 18:51:22:0153>   CONNECT ACKNOWLEDGE Q931 Call_reference=2 ORIG

RCV on 1 at 18:51:53:0088>   DISCONNECT Q931      Call_reference=2 DEST
    IE #01: Cause              80 90

SND on 1 at 18:51:53:0114>   DISCONNECT Q931      Call_reference=2 ORIG
    IE #01: Cause              80 90

RCV on 1 at 18:51:53:0324>   RELEASE Q931         Call_reference=2 DEST

SND on 1 at 18:51:53:0344>   RELEASE COMPLETE Q931 Call_reference=2 ORIG

```

## Using ppptrace

The command line facility for tracing and recording the PPP activity is called `ppptrace`. Use `ppptrace` to trace PPP packets sent and received by all PPP links. The `-x` option is used to provide information for the entire PPP packet.

▼ To Run `ppptrace`

◆ Become superuser, enter the following command and press Return:

```
# ppptrace
```

*Example Trace 1: Taken from an Outgoing Call*

This example trace was taken on making an outgoing call such as ping.

```
14:35:25: max172_0 Send: LCP Packet Config Request [id: 00]
[length: 001b]
    Maximum Receive unit: 3000
    Magic Number: 01a2989f
    Multilink Max-Receive-Reconstructed-Unit: 3200
    Multilink Endpoint-Discriminator: IEEE 802.1 Globally
Assigned MAC Address (08:00:20:77:f0:8f)

    ff 03 c0 21 01 00 00 1b 01 04 0b b8 05 06 01 a2
"...!....."
    98 9f 11 04 0c 80 13 09 03 08 00 20 77 f0 8f
".....w.. "

14:35:26: max172_0 Send: LCP Packet Config Request [id: 01]
[length: 001b]
    Maximum Receive unit: 3000
    Magic Number: 01a2989f
    Multilink Max-Receive-Reconstructed-Unit: 3200
    Multilink Endpoint-Discriminator: IEEE 802.1 Globally
Assigned MAC Address (08:00:20:77:f0:8f)

    ff 03 c0 21 01 01 00 1b 01 04 0b b8 05 06 01 a2
"...!....."
    98 9f 11 04 0c 80 13 09 03 08 00 20 77 f0 8f
".....w.. "
```

## *Problems Calling a Remote System*

Use `ping(1M)` to call one of the remote systems connected to your IP/ISDN network. Before doing this, SunISDN must be configured and running on the remote system and a path to this system must be defined in the IP/ISDN map.

If no answer is received from the remote system, check the journal file for status and error messages.

```
# ping remote_system-i
no answer from remote_system -i
#
# tail -f /var/opt/SUNWisdn/log
```

## *No Dialing Status Message*

- 1. Check that the IP/dialup interface used to route IP datagrams to the remote system is active.**

The IP/dialup interface should be marked `flags=<UP,RUNNING>`. If the IP/dialup interface is not active, check the shell commands entered in the IP/ISDN map.

```
# /usr/sbin/ifconfig -a
```

- 2. Check the routing table on your local system using `netstat(1M)` to display it.**

A route to the remote system (or the network to which it is attached) via the IP/ISDN interface is displayed.

```
# /usr/bin/netstat -r
```

If there is a problem with the routing table you can use the `route(1M)` command to adjust it manually. You can flush the current table by typing:

```
# /usr/sbin/route -f
```

## *Connection Failure*

A connection failure usually indicates a problem between your system and the local connection to the ISDN exchange (the phone-jack). Occasional connection failures may occur during normal operation and can be ignored. Systematic data link failures normally indicate a hardware (layer 1) problem. You may have a problem with the ISDN hardware interface installed in your system, a problem with the cable connecting your system to the ISDN, or a problem with the ISDN line installed to your premises.

Check the hardware interfaces installed in your system. Also check the cables between your system and the local connection to the ISDN line. Check if the ISDN is working and the quality of the connection by making a call with an ISDN-compatible telephone.

## *Problems Communicating with a Remote System*

If the connection to the remote system is successful, but the remote system does not respond, there may be a problem sending data to or receiving data from the remote end.

Use `snoop(1M)` to capture the packets transmitted across the network. Run `snoop` on the IP/dialup interfaces at both the local and remote ends and repeat the `ping` command.

```
# snoop -d ifpppnum
# ping remote_system -i
```

The `icmp` echo request packets leave the local system and arrive at the remote system. The `icmp` echo response packets then leave the remote system and arrive at the local system.

### `icmp` echo request *Packets Do Not Arrive At the Remote End*

For systems connected across an AT&T 5ESS 5e5 conformant network in the United States, this may indicate that you are trying to send data at a rate of 64 kbps over a link that only supports a 56 kbps service. In this case, try configuring both the local system and the remote system to transmit data across the B-channel at 56 kbps.

For systems connected across other network types, this may indicate that the Point-to-Point Protocol (PPP) has failed to establish a direct link between the two systems. Check for PPP errors in `/var/opt/SUNWisdn/log`.

### `icmp echo response` *Packets Are Not Returned*

If `icmp echo request` packets arrive at the remote end, and the remote system does not return `icmp echo response` packets, the problem may be located at the remote end only. A routing problem may exist at the remote end. Repeat the diagnostic tests on the remote system.

## IP Routing Problems

A common error when using SunISDN to transmit IP datagrams across the ISDN results from incorrect or inefficient IP routing. For more information about IP routing refer to the *Solaris 2.5 Administering TCP/IP and UUCP*.

As a general rule, follow these guidelines:

1. You can remove redundant or duplicate routes from the IP routing table using the `route(1M)` command.

```
# route delete destination gateway
```

## IP Routing/Addressing Problems

Problems can occur when using the Dynamic IP Address (`negotiate_address`) or the Dynamic Default Route (`default_route`) features as follows:

### **Dynamic IP Address**

Dynamic IP Address (`negotiate_address`) should be enabled on the Client (calling) system only, when enabled it allows the called system (Server) to modify or assign the IP address of the client. As the client system source address is likely to change if this feature is enabled, you must first `ping` the destination host before attempting a `telnet` or `rlogin` session. The purpose of this, is to establish a new address. Note the `ping` may fail. This feature should only be enabled if you have not been assigned a *fixed* IP address by your Internet Service Provider (ISP) or by the site you are connecting to.

### **Dynamic Default Route**

The Dynamic Default Route (`default_route`) feature allows an ISDN/PPP connection to become the default route but only while the connection is established. When the PPP connection is established, an entry will be made in the routing tables, specifying the remote host as the default router. The entry is removed when the connection is dropped.

Problems arise when the remote host is a router (likely case if connecting to an ISP) and Dynamic Default Route is enabled. When this is the case, you will first have to `ping` the remote host (to setup the routing tables), before trying to connect to other host or sites beyond that router. Use of Dynamic Default

Route is not recommended. If you want the ISDN/PPP interface to be the default route (most people do if connected to an ISP), then use the `static` option in `isdntool`.

## *Problems with Asynchronous PPP*

If you experience problems with asynchronous PPP, remove the asynchronous PPP packages and reinstall them.

- 1. Become superuser and use `pkgrm` to remove the following packages:**  
SUNWapppr, SUNWapppu, SUNWpppk.

```
# pkgrm package name
```

Each package must be removed individually.

- 2. Reinstall asynchronous PPP using its instructions.**



## *Status Messages*

---



This chapter lists error messages that may be displayed due to networking problems.

### *Standard Messages Returned by CCITT Compliant Networks*

The following messages come from CCITT, the standards body that created the ISDN standard. These messages are received from networks conforming to the ETSI, ISDN2, and INS-Net64 specifications and are returned in `/var/opt/SUNWisdn/log`.

**Cause 1: Unassigned number**

Although the ISDN number was presented in a valid format, it is not currently a valid number.

**Cause 2: No route to specified transit network**

The ISDN exchange was asked to route the call through an intermediate network that is unrecognized.

**Cause 3: No route to destination**

The call was actually routed through a network that does not serve the destination address.

**Cause 6: Channel unacceptable**

The quality of service provided by the specified channel was insufficient to accept the connection.

**Cause 7: Call awarded and delivered in an established channel**

The user was awarded an incoming call and the call is being connected to a channel that is established for similar calls.

**Cause 16: Normal call clearing**

Reports the normal clearing of a call.

**Cause 17: User Busy**

The called system acknowledged the connection request, but is unable to accept the call because the B-channels are currently in use.

**Cause 18: No user responding**

The connection could not be completed because the destination failed to respond to the call.

**Cause 19: No answer from user (user alerted)**

The destination responded to the connection request but failed to complete the connection within the prescribed time. Problem at the remote end.

**Cause 21: Call rejected**

The destination was capable of accepting the call (was neither busy nor incompatible) but rejected the call for some other reason.

**Cause 22: Number changed**

The ISDN number used to set up the call is no longer assigned to any system. If an alternate address was assigned to the called equipment, it may be returned in the diagnostic field of this message.

**Cause 26: Non-selected user clearing**

The destination was capable of accepting the call (was neither busy nor incompatible) but rejected the call because it was not awarded to the user.

**Cause 27: Destination out of order**

The destination could not be reached because the interface was not working correctly, and a signaling message could not be delivered. This may be a temporary fault that can last for a relatively long time. For example, equipment off-line.

**Cause 28: Invalid number format**

The connection could not be established because the destination address was presented in an unrecognized format or because the destination address was incomplete.

**Cause 29: Facility rejected**

The facility requested by the user could not be provided by the network. This could be a subscription problem.

**Cause 30: Response to STATUS ENQUIRY**

The status message was generated in direct response to the prior receipt of a status enquiry message.

**Cause 31: Normal, unspecified**

The occurrence of a normal event is reported when no standard cause applies. No action required.

**Cause 34: No circuit/channel available**

The connection could not be established because there was no appropriate channel available to handle the call.

**Cause 38: Network out of order**

The destination could not be reached because the network was not working correctly, and the condition is expected to last for a relatively long time. An immediate re-connect attempt is likely to be unsuccessful.

**Cause 41: Temporary failure**

An error occurred because the network is not functioning correctly, but this problem is likely to be resolved shortly.

**Cause 42: Switching equipment congestion**

The destination could not be reached because the network switching equipment was temporarily overloaded.

**Cause 43: Access information discarded**

The network could not provide the requested access information.

**Cause 44: Requested circuit/channel not available**

The remote equipment could not provide the requested channel.

**Cause 47: Resource unavailable, unspecified**

The requested channel or service was unavailable.

**Cause 49: Quality of service unavailable**

The requested quality of service (as defined by CCITT recommendation X.213) could not be provided by the network. This may be a subscription problem.

**Cause 50: Requested facility not subscribed**

The remote equipment supports the requested supplementary service, but the service is only available by subscription.

**Cause 57: Bearer capability not authorized**

The user requested a bearer capability that the network provides, but the user is not authorized to use. This may be a subscription fault.

**Cause 58: Bearer capability not presently available**

The network is normally able to provide the requested bearer capability, but not at the present time. This may be a temporary network problem or a subscription problem.

**Cause 63: Service or option not available, unspecified**

The network or remote equipment was unable to provide the requested service. This may be a subscription problem.

**Cause 65: Bearer capability not implemented**

The network is not capable of providing the bearer capability requested by the user.

**Cause 66: Channel type not implemented**

The network or the destination equipment does not support the requested channel type.

**Cause 69: Requested facility not implemented**

The remote equipment does not support the requested supplementary service.

**Cause 70: Only restricted digital information bearer is available**

The network is unable to provide *unrestricted* digital information bearer capability. This bearer capability is essential to run SunISDN.

**Cause 79: Service or option not implemented, unspecified**

The network or remote equipment was unable to provide the requested service option for an unspecified reason. This may be a subscription problem.

**Cause 81: Invalid call reference value**

The remote equipment has received a call with a call reference that is not currently in use by the user-network interface.

**Cause 82: Identified channel does not exist**

The receiving equipment was requested to use a channel that is not activated on the interface for calls.

- 
- Cause 83: A suspended call exists but this call identity does not**  
The network received a call resume request. The call resume request contained a Call Identity information element, which indicates that it is in use for a suspended call.
- Cause 84: Call identity in use**  
The network received a call resume request. The call resume request contained a Call Identity information element, which indicates that it is in use for a suspended call.
- Cause 85: No call suspended**  
The network received a call resume request when there was not a suspended call pending. This may be a transient error that will be resolved by successive retries.
- Cause 86: Call having requested call identity has been cleared**  
The network received a call resume request. The call resume request contained a Call Identity information element, which once indicated a suspended call; however, that suspended call was cleared either by timeout or by the remote user.
- Cause 88: Incompatible destination**  
An attempt was made to connect to non-ISDN equipment such as an analog line.
- Cause 91: Invalid transit network specified**  
The ISDN exchange was asked to route the call through an intermediate network that is unrecognized.
- Cause 95: Invalid message, unspecified**  
An invalid message was received and no standard cause applies. D-channel error. If this error is returned systematically, report the occurrence to your authorized service provider.
- Cause 96: Mandatory information element is missing**  
The receiving equipment received a message that did not include one of the mandatory information elements. D-channel error. If this error is returned systematically, report the occurrence to your authorized service provider.

**Cause 97: Message type non-existent or not implemented**

The remote equipment received a message that was not recognized either because the message type was invalid, or because the message type was valid but not supported. This is either a problem with the remote configuration or a problem with the local D-channel.

**Cause 98: Message not compatible with call state or message type non-existent**

The remote equipment received an unexpected message that did not correspond to the current state of the connection. D-channel error. If this error is returned systematically, report the occurrence to your authorized service provider.

**Cause 99: Information element non-existent or not implemented**

A message was received by the remote equipment that contained information elements that were not recognized. D-channel error. If this error is returned systematically, report the occurrence to your authorized service provider.

**Cause 100: Invalid information element contents**

A message was received by the remote equipment that included invalid information in the information element. D-channel error.

**Cause 101: Message not compatible with call state**

The remote equipment received an unexpected message that did not correspond to the current state of the connection. D-channel error.

**Cause 102: Recovery on timer expiry**

An error-handling (recovery) procedure was initiated by a timer expiry. This should be a temporary problem.

**Cause 111: Protocol error, unspecified**

An unspecified D-channel error when no other standard cause applies.

**Cause 127: Interworking, unspecified**

An event occurred but the network does not provide causes for the actions that it takes; therefore the precise nature of the event cannot be given. This may, or may not, indicate the occurrence of an error.

**Cause UNKNOWN: Unknown or local error**

An event occurred but the network does not provide causes for the actions that it takes; therefore the precise nature of the event cannot be given. This may, or may not, indicate the occurrence of an error.

## *Configuration Example*

---



This appendix provides example syntheses of an ISDN configuration file and a PPP configuration file and explains what occurs between the two machines in the examples. This appendix also includes sample ISDN and PPP configuration files with explanatory notes.

### *SunISDN Configuration Example*

Table A-1 shows a synthesis from an ISDN configuration file example. This example configuration file shows two machines set up to talk over an ISDN network.

*Table A-1* /etc/opt/SUNWisdn/te configuration file

Hostname: isdn3			Hostname: isdn5			
File	0	1	0	0	1	1
Line type	PTP	PTP	MTP	MTP	MTP	MTP
profile	A	A	A	B	A	B
cc_calling_nb	1111111	1111111	3333333	4444444	5555555	6666666
cc_na_country	usa	usa	usa	usa	usa	usa
cc_na_operator	5ess	5ess	dms	dms	dms	dms
cc_force56	off	off	off	off	off	off
ns_spid	nil	nil	4153333333	4154444444	4155555555	4156666666

The ISDN physical layer looks at these fields as phone number connections. PPP looks at these connections as between isdn3 and isdn5, which are the host names for the first and second machines.

The other required fields in this file are the country (`cc_na_country`) field and the operator (`cc_na_operator`) field where you specify the switch type.

Code Example A-1 is a sample `isdn.cf` file as it would be displayed on your screen.



```
# SunISDN 1.04 configuration file
# isdn.cf
#-----
isdn_config# ISDN configuration
#-----
# Warning: dms, 5ess (multipoint) and ni2 switch types may support
# 1DN, 1DN+1SPID or 2DNs +2SPIDs. Therefore, two cc_profiles and
# two ns_profiles may be configured over the same dl and physical interface.
# Other switch types must always have a single cc_profile and a
# single ns_profile configured.
#-----
cc_config# Call Control parameters
#-----

# about force 56:
# A 56Kb outgoing call may appear as a 64Kb call on the incoming side,
# due to configuration problems in the network. If this error occurs,
# set the cc_force56 option to on to enforce a 56K baud rate.

# about local address:
# If present, the incoming call called address will be checked against
# the specified local address(es). If there is no match, the incoming call
# will be rejected. Up to 4 local addresses are supported per nai.
#
# In a NI-1/2 multipoint configuration, if the Sun is configured with
# 2 profiles (A & B), each profile must have a local address configured
# and equal to the calling number. The local address will be used to
# filter calls which do not have an Endpoint ID.
#
# If connected to a 1TR6 Multipoint switch (Germany), you must set the
# cc_calling_nb and cc_local_nb to the EAZ value assigned by your ISDN provider.
# The EAZ (1-9) is used to differentiate several devices connected to the
# same multipoint line. EAZ (0) is used to broadcast an incoming call to all
# devices. EAZ does not apply to 1TR6 point-to-point.
```

```

# PROFILE_A
cc_profile A
cc_calling_nb |>calling-number-or-EAZ<|

#cc_calling_sub_add |>calling-sub-add<|

#cc_local_nb |>local-nb-or-EAZ-or-calling-nb<| # optional
#cc_local_sub_add |>local-sub-add<| # optional

#cc_local_nb |>local-nb<| # optional
#cc_local_sub_add |>local-sub-add<| # optional
#cc_local_nb |>local-nb<| # optional
#cc_local_sub_add |>local-sub-add<| # optional
#cc_local_nb| >local-nb<| # optional
#cc_local_sub_add |>local-sub-add<| # optional
#cc_force56 on
#cc_cli on

cc_na_country usa # australia france germany japan uk europe sweden
cc_na_operator ni2 # aul vn2 tr6 ntt etsi dms 5ess ni2

#-----
# PROFILE_B-- not needed for att-ptp or non-US switch types

#cc_profile B
#cc_calling_nb |>calling-number<|

#cc_calling_sub_add |>calling-sub-add<|

#cc_local_nb |>local-nb-or-calling-nb<| # optional
#cc_local_sub_add |>local-sub-add<| # optional

#cc_local_nb |>local-nb<| # optional
#cc_local_sub_add |>local-sub-add<| # optional
#cc_local_nb |>local-nb<| # optional
#cc_local_sub_add |>local-sub-add<| # optional
#cc_local_nb |>local-nb<| # optional
#cc_local_sub_add|>local-sub-add<| # optional
#cc_force56 on
#cc_cli on

#cc_na_country usa # australia france germany japan uk europe sweden
#cc_na_operator ni2 # aul vn2 tr6 ntt etsi dms 5ess ni2

#
# Note: ns_spid should be commented out for non US switch types.

```

```
#-----
ns_config# Network Signalling parameters (Q.931)
#-----
ns_profile A
ns_spid |>spid-A-or-nil<|# US only

#-----
# PROFILE_B-- not needed for att-ptp or non-US switch types

#ns_profile B
#ns_spid |>spid-B-or-nil<|# US only

#-----
dl_config# Data-Link parameters(Q.921/LAPD)
#-----

# PLEASE comment out the following lines for non-US switch types.
# BEGIN US switch specific parameters (DMS, AT&T, NI-1/2)

dl_tei_time_assignment DL_TEI_TIME_ASSIGN_USA
dl_tei_time_removal DL_TEI_TIME_REMOVAL_USA

dl_sapi          0# SIG
dl_dlcep_nb      3      # if 2DNs/2SPIDS configured, set to 3 (nil/2, dms, att-mtp)
                  # if switch is att-ptp or 1DN/1SPID configured, set to 2
                  # if sharing mpt-line with a phone, set to 2 (mixed voice-data)
                  #
dl_rc_nb         1000# N202 retry count to activate layer 2

dl_sapi          63# MGT
dl_dlcep_nb      3      # if 2DNs/2SPIDS configured, set to 3 (nil/2, dms, att-mtp)
                  # if switch is att-ptp or 1DN/1SPID configured, set to 2
                  # if sharing mpt-line with a phone, set to 2 (mixed voice-data)
                  #
dl_rc_nb         1000# N202 retry count to activate layer 2
# END of US switch parameters

#-----
ph_config# Physical layer parameters
#-----
```

*Code Example A-1* Sample ISDN Configuration File

## PPP Configuration File Example

Table A-2 shows a synthesis of a PPP configuration file example. In this example, you must enter the following command line to set up the interface to the network. The two host names in this example file are isdn3 and isdn5. The `ifconfig` line for the first `isppp.cf` file is

```
# ifconfig ifppp0 plumb isdn3 isdn5 netmask + up
```

Table A-2 /etc/opt/SUNWisdn/isppp.cf Configuration File

Field	ifconfig ifppp0 isdn3 to isdn5	ifconfig ifppp0 isdn5 to isdn3
use_caller_id	on	on
isdn_path		
name	isdn5	isdn3
default_route		
network	nil	nil
interface	ifppp0	ifppp0
inactivity_timeout	30	35
ipsetup_timeout	180	120
negotiate_address	off	off
callback	off	off
callback_timeout	10	10
reenable_timeout	30	30
called_number	3333333 data56	1111111 data56
called_number	4444444 data56	1111111 data56
called_number	5555555 data56	2222222 data56
called_number	6666666 data56	2222222 data56
ipcp_compression	off	off
security_card	off	off
will_do_authentication	chap	chap

Table A-2 /etc/opt/SUNWisdn/isppp.cf Configuration File (Continued)

Field	ifconfig ifppp0 isdn3 to isdn5	ifconfig ifppp0 isdn5 to isdn3
require_authentication	chap	chap
pap_id	off	off
pap_password	off	off
pap_peer_id	off	off
pap_peer_password	off	off
chap_secret	isdn3	isdn5
chap_name	isdn3	isdn5
chap_peer_secret	isdn5	isdn3
chap_peer_name	isdn5	isdn3
lcp_encapsulation	MP	MP
lcp_mrru	1600	1600
lcp_endpoint	off	off
encapsulate_cp	off	off
ccp	ccp	ccp
compression	stac	stac
stac_check_mode	lcb	lcb
bandwidth_controller	on	off
hiwat	60	off
hicnt	2	off
lowat	20	off
locnt	4	off
clamp	2	off
bandwidth	1	off
link_retry_count	3	off
link_suspend_timer	300	off
hunt_mode	off	off

Table A-2 /etc/opt/SUNWisdn/isppp.cf Configuration File (Continued)

Field	ifconfig ifppp0 isdn3 to isdn5	ifconfig ifppp0 isdn5 to isdn3
restart_timer	3000	off
mac_restarts	20	off
lcp_mru	1524	off

If isdn3 wanted to connect with several other machines on the network, the ifconfig line would be repeated and the host name of each machine you expect to connect with is listed. isdn3 would always appear in the first position but the second machine might be isdn4, isdn6, and isdn9 in three additional ifconfig lines.

Each ifconfig line must have an associated isdn\_path, so the section starting at the path name and concluding with the bandwidth must be complete for isdn4, isdn6 and so on. Keep in mind that the isdn\_path name refers to a system to which you want to connect, *not* your system.

ifppp0 in both the ifconfig line and in the isdn\_path interface must match to separate different paths. For example if the next path to be defined were for isdn4, then the second ifconfig line would start “ifconfig ifppp1” and the isdn\_path name would be isdn4 and the interface would be ifppp1. isdn6 could be ifppp2 and so on.

Even though force56 is commented out in the ISDN file, the data rate is set to data56 in the isppp.cf (the called number line) so that will determine the baud rate for the connection.

Both caller ID and CHAP are set for both systems. Thus the CHAP password will be sent if requested for an incoming call, and the called system will request a CHAP password in return.

isdn3 controls the bandwidth and aggregation of B channels between the two machines.

The called\_number may or may not include country or area code. This is determined in the same way you make a phone call. In the United States for example, if your area code is 415 and you are calling a number in the 213 area, you must dial 1 plus the 213 area code to complete the phone call. You must do the same to complete an ISDN connection, so you would include 1 and 213 as part of the called\_number in the isppp.cf file.

---

Keep in mind that while the `chap_secret` password is sent encrypted, anyone reading the `isppp.cf` file can read and use your password. Using CLI or Callback with PAP or CHAP makes it much more difficult for someone else to emulate your system.

The Code Example A-2 shows the sample `isppp.cf` file as it would be displayed on your screen.

```

#pragma ident "@(#)isppp.cf1.31 96/02/13 SMI"
#
# SunISDN 1.0.4 - ispppd configuration file
#

version 1

#-----

#defaults# can be used to define attributes common to all paths.

#-----
# IP/PPP Interface Plumbing
#
# IP supports point-to-point interfaces.
# Please select an interface type and edit the ifconfig command accordingly.
# This line will get executed each time the isppp start-up script is invoked
# (i.e at boot time). Refer to ifconfig(1M) man pages for more details.
# We recommend using point-to-point interfaces as a general rule.

#

#ifconfig ifppp0 plumb |>local-hostname<| |>remote-hostname<|
#netmask + up private

#

# PLEASE remove the following line.
ifconfig - ;echo "ISPPP configuration error, Please edit /etc/opt/SUNWisdn/isppp.cf"

# Use "ifconfig -a" and/or "netstat -i" to check the created interfaces after start-up

#-----
# Routing
#
# You can set-up static routes to various remote systems using the generic
# route command directly in isppp.cf. This command will get executed
# each time the isppp start-up script is invoked. refer to route(1M)
# man pages for more details. If you need to set-up a default route
# pointing to a default router (typically the case when connection to an
# Internet provider), it is preferable to edit /etc/defaultrouter.

#route add hostname gateway 1

```



```
# Using static routes is the most cost effective solution and best for telecommuting
# application. If you choose to use Dynamic Routing Protocols such as
# RIP or Router Discovery, you can force your system to become a router
# by doing a touch /etc/gateways (do not set-up /etc/defaultrouter in this case).
# We recommend reading the in.rdisc (1M) and in.routed (1M) man pages.
# In.routed will typically send routing updates every 30s, and in.rdisc will
# send advertise messages every 10 minutes which will cause some unwanted phone calls.
# Note:
#   RIP can be blocked by inserted the following line in /etc/gateways:
#   i.e norip ifppp0
#   i.e noripin ifppp0
#   i.e noripout ifppp0
#   Router Discovery transmit intervals can be tuned using the -T option:
#   i.e /usr/sbin/in.rdisc -r -T <time_interval>
# Another option is to set-up gated.
#
#-----
# If use_caller_id set to off, or if the calling_address is not provided by
# the ISDN service provider, make sure the pap/chap information is UNIQUE
# for each path. PAP or CHAP must be used when caller-id is not present
# as it is the only way to associate an IP/PPP path with an incoming
# connection request.
#
# If use_caller_id is set to on and the calling_address is presented
# by the network, neither pap nor chap will be used to find to associate
# a path with an incoming connection request. the PPP manager will rely
# exclusively on the calling_address. If you have defined several paths to
# the same remote (same remote address) or if you wish to identify client
# connections solely based on pap/chap (i.e nomadic system), turn this
# option to off.
#
#use_caller_id off # default is on
#-----
# Uncomment the isdn_path keyword to create a path object

#isdn_path
#name |>any-name-typically-remote-hostname<|
# default_route# ifppp interfaces only
#network nil # MUST BE SET TO "ntt" in JAPAN
#interface ifppp#
#peer_ip_address|>gateway<| #
#inactivity_timeout 120
#ipsetup_timeout 120
```

```

#-----
# client side dynamic addressing (applies to ifppp interfaces only)
# The client side address will be provided by the server after ppp negotiation.
# A "Bogus" address must be used on the client to plumb-up the interface (see
# ifconfig command above).
# i.e ifconfig ifppp0 plumb bogus_address server up
#
#negotiate_address on|off
#-----
# Call Back
#
# This should typically be enabled on the callback server
#callback on #default is off
#
#callback_timeout 5
#-----
# This should be set on the client. It will disable the path until
# the server actually calls back (to avoid any call collision problem).
#
#reenable_timeout 30
#-----
# Dial-up parameters
#
# called_number: remote system directory number (address,sub_address if any)
# grouping: always 1 for BRI
# interface: local physical isdn interface name (of the form name_index),
# use "any" for automatic physical interface selection.
#
# profile: local call control profile, A or B or any
# (US multipoint switches may have 2 profiles
# configured, with each a different SPID and DN.
# Other switch types always use profile A. )
# use "any" for automatic profile selection.
#
# service: B channel baud rate (data56:56000bps or data64:64000bps HDLC,
# 64000bps support depends on SS7
# availability between local exchanges)
#
# dir-number grouping interface profile service
# -----
#called_number |>DN<| 1 isdn_0 A |>set-this-to-data56-or-data64<|
#called_number |>DN<| 1 isdn_1 B |>set-this-to-data56-or-data64<|
#called_number |>DN<| 1 any any |>set-this-to-data56-or-data64<|

```

```
#-----
# Compression

# IP header compression
#   #ipcp_compression off # default is vj
# PPP header compression
#   #lcp_compression off # not supported in 1.0.4
# Data compression
#   #ccp                ccp or off
#   #compression        stac_ascend or stac
#   #stac_check_mode    off or lcb or crc or sequence3
#-----
# Secure Access
#
# Secure access has been developed for Sun's worldwide ISDN telecommuting
# project.
# SunISDN 1.0.4 fully interoperates with Ascend's secure server solution
# based on Enigma digital token (DES Gold) and RADIUS.
#
# PAP authentication must be enabled when using this option
# (refer to example here below).
#
#   #security_card      on # default is off
#   #will_do_authentication pap or pap_token_chap
# in this context,
# pap_token_chap means that the first link will use pap based
# enigma authentication; subsequent link(s) will use chap based
# authentication.
# pap means that pap based enigma authentication will be used and
# therefore the user will have to respond to a network challenge
# each time a new link is added to the multilink bundle.

#require_authentication off
#negotiate_address      on
#pap_id                 InitialsemployeeID
#pap_password           SAFEWORd # must be SAFEWORd
#pap_peer_id           InitialsemployeeID
#pap_peer_password     SAFEWORd
# configure only when pap_token_chap method is used.
#chap_secret            |>choose-and-set-a-secret<|
#chap_name              |>local-hostname<|
#chap_peer_secret      |>choose-and-set-a-peer-secret<|
#chap_peer_name        |>remote-hostname<|
```

```

#-----
# Authentication parameters
#
# Note: The Sun PPP implementation supports true full duplex authentication
# and this regardless of the direction of the call. However this may
# not be true for other vendor implementations. Interoperability testing
# with Ascend showed that Ascend products only support half duplex
# authentication (when used as servers) and therefore Sun clients
# (initiating calls) should have "require_authentication" set to "off".
#
# Set "require_authentication" to "off" when connected to an Ascend server
# (which is in most cases true when connecting to an ISDN Internet
# Provider).
# Interoperability testing with Cisco showed that it supports both PAP
# and CHAP full duplex authentication.
# To interoperate with Windows NT ISDN/PPP you must use pap
# authentication as Sun does not support MS-CHAP. We suggest the
# following: will_do_authentication chap pap
#
#will_do_authentication |>set-this-to-pap-or-chap<|
#require_authentication |>set-this-to-off-or-pap-or-chap<|
#
#pap_id |>local-hostname<|
#pap_password |>choose-and-set-a-password<|
#pap_peer_id |>remote-hostname<|
#pap_peer_password |>choose-and-set-a-remote-password<|
#
#chap_secret |>choose-and-set-a-secret<|
#chap_name |>local-hostname<|
#chap_peer_secret |>choose-and-set-a-peer-secret<|
#chap_peer_name |>remote-hostname<|
#-----
# Encapsulation
#
# SunISDN 1.0.4 supports RFC1717 (PPP Multilink protocol) including
# packet re-ordering and re-assembly of fragmented packets.
# To enable PPP Multilink set the encapsulation parameter to "MP".
# lcp_mrru, lcp_sseqnum and lcp_endpoint are irrelevant when
# using PPP encapsulation (refer to documentation for more details
# on these parameters).

```

```
#lcp_encapsulation      MP      # default is PPP

      #lcp_mrru          1600 # valid range is 60-3000
#lcp_sseqnum            on # default is off
# Endpoint format (see rfc1717 page 14), ppp magic number is
# generated by kernel so class 3 does not take any argument.
      #lcp_endpoint      off  # do not send endpoint
      #lcp_endpoint      nil  # class 0
      #lcp_endpoint      local localaddress # class 1
      #lcp_endpoint      ip   255.255.255.255 # class 2
      #lcp_endpoint      mac  01:02:03:04:05:06 # class 3
      #lcp_endpoint      ppp  # class 4
      #lcp_endpoint      psndn directorynb  # class 5

# This parameter is provided for interoperability with MP implementations
# which do not negotiate CPs over the MP bundle and may wait for more
# than 1 link to be up before sending MP encapsulated packets.

      #encapsulate_cp  off # default is on
#-----
# Bandwidth On Demand
#
# For telecommuting: we recommend to set-up a server with
# bandwidth_controller set to on and callback set to on.
# The client will be able to call-in, the server will then call back
# and add additional links if necessary (up to 640 Kbps or 10links max).
# To avoid any call collisions, only one of the systems should act as
# a bandwidth controller. Internet Service providers do not support callback
# and in this case the client machine must be setup as a bandwidth controller.
#
# Additional called_number entries must be added under the Dial-up
# section in order to configure a system with multiple links (or
# channel aggregation).
#
# Note: SunISDN 1.0.4 does not support BONDING. It supports the
# the industry standard RFC1717 recommendation (or PPP Multilink).
      #bandwidth_controller  on
      #hiwat                60
      #hicnt                2
      #lowat                20
      #locnt                4
      #clamp                2 # clamped links will not get deleted
#bandwidth                1 # desired nb of aggregated links
#link_retry_count         3 # retry n times and blacklist this link
#link_suspend_timer      300 # keep blacklisted for timer duration
```

```

#-----
# Client side software hunt is incompatible with callback/bandwidth_controller
# Client will sequentially call the list of remote numbers (each called_number
# entry) until a connection is made or the list of numbers is exhausted.
#
#   #hunt_mode  on|off
#-----
# Misc.
#restart_timer  3000  # default RFC value is 3000ms
#max_restarts   20   # default RFC value is 10
#lcp_mru        512  # default mru is 1500 (60-3000 range)

#-----
#   isdn_path
#-----
#isdn_path
#name |>any-name-typically-remote-hostname<|
#default_route # ifppp interfaces ONLY
#network      nil # MUST BE SET TO "ntt" in JAPAN
#interface ifppp #
#peer_ip_address |>gateway<| #
#inactivity_timeout  120
#ipsetup_timeout     120
#negotiate_address   on|off
#callback            on #default is off
#callback_timeout    10
#reenable_timeout    30
#called_number      |>DN<| 1 any any |>set-this-to-data56-or-data64<|
#ipcp_compression   off # default is vj
#lcp_compression    off # default is on
#security_card      off
#will_do_authentication |>set-this-to-pap-or-chap<|
#require_authentication |>set-this-to-off-or-pap-or-chap<|
#pap_id             |>local-hostname<|
#pap_password       |>choose-and-set-a-password<|
#pap_peer_id        |>remote-hostname<|
#pap_peer_password  |>choose-and-set-a-remote-password<|
#chap_secret        |>choose-and-set-a-secret<|
#chap_name          |>local-hostname<|
#chap_peer_secret   |>choose-and-set-a-peer-secret<|
#chap_peer_name     |>remote-hostname<|
#lcp_encapsulation  MP      # MP (RFC1717) or PPP
#lcp_mrru           1600
#lcp_sseqnum        off
#lcp_endpoint       off

```

```
#encapsulate_cp on
#ccp                ccp # off
#compression        stac_ascend # stac (IETF)
#stac_check_mode    lcb
#bandwidth_controller on
#hiwat              60
#hicnt              2
#lowat              20
#locnt              4
#clamp              2# clamped links will not get deleted
#bandwidth          1 # desired nb of aggregated links
#link_retry_count   3 # retry n times and backlist this link
#link_suspend_timer 300 # keep blacklisted for timer duration
#hunt_mode          on|off
#restart_timer      3000 # default RFC value is 3000ms
#max_restarts       20 # default RFC value is 10
#lcp_mru            1524 # default mru is 1500
```

*Code Example A-2* Sample PPP Configuration File





# Quick SunISDN Installation and Configuration

---



This appendix provides guidelines for an experienced SunISDN user to quickly install and configure SunISDN 1.0.4.

## ▼ To Install and Configure SunISDN Quickly

1. **Collect the necessary information from your phone company regarding your configuration.**
2. **Become superuser.**
3. **Remove existing ISDN packages.**  
Refer to the `pkginfo` and `pkgrm` instructions for both `ppp` and `isdn` in Chapter 3, “Installing SunISDN 1.0.4.”
4. **Install SunISDN 1.0.4 software using `pkgadd`.**  
See Chapter 3, “Installing SunISDN 1.0.4.”
  - a. **`pkgadd` loops back to the installation menu and asks, “Do you want to continue...”. Keep replying `y` (yes) until you have installed all the packages.**  
Installation takes 5-10 minutes.
  - b. **Quit `pkgadd` when it starts to repeat the cycle through the packages.**
  - c. **Use `pkginfo` for `ppp` and `isdn` when you complete the installation to verify that all the packages are installed.**

**5. Set up your environment.**

See Section , “Setting Up Your Environment,” on page 23 for details.

**6. Configure the ISDN and PPP configuration files, using the graphical user interface or a text editor.**

See Chapter 4, “Using the GUI to Configure SunISDN 1.0.4,” or Chapter 5, “Using a Text Editor to Configure SunISDN 1.0.4,” for more information.

**a. To configure ISDN you will need the following information for your local system:**

- Network type—your local phone company switch.
- Your phone number (also known as calling or local phone number)—If you have more than one phone number you must enter *all* of them. Each line, `isdn_0`, `isdn_1...` `isdn_n` can accommodate two phone numbers. Do not add area, country, city, other additional codes, dashes, spaces, parentheses, or other punctuation.
- Use default settings for all other fields.

**b. To configure PPP, you will need the following information for the remote system:**

- Name—any identifying name you will remember.
- Interface—point-to-point.
- Source—the host name or IP address of your machine.
- Destination—the host name or IP address of the machine you are calling.
- Called Number—the phone number you are calling.
- The identifier name/password combination you will need for both your local site and the remote site if either you or the remote site require PAP, CHAP, or PAP-Token-CHAP authentication.

**7. Reboot your system. ping the remote machine.**

If the response says the machine is alive, your connection succeeded.

## *Glossary*

---

<b>address mask</b>	A bit mask used to select bits from an Internet address for subnet addressing. The mask is 32 bits long and selects the network portion of the Internet address and one or more bits of the local portion. Sometimes called subnet mask.
<b>analog</b>	Continuous signals or data that can have any value within a predefined range.
<b>asynchronous</b>	Operation that caters for variable timing between information segments usually using controls bits embedded within the information itself. Often used to refer to any time-insensitive application.
<b>baud</b>	Bits At Unit Density. Measurement rate for transfer of data over a network in bits per second. The basic ISDN baud rate is 64 kbps (thousand bits per second).
<b>BRI</b>	Basic Rate Interface (2B+D). One of the standard ISDN interfaces defined by the CCITT protocols. Consists of two B-channels (64 kbps) and one D-channel (16 kbps).
<b>B channel</b>	ISDN bearer service channel. Carries digital voice and/or data transmission at a rate of 64 kbps. Primarily used for data (as opposed to signaling) transmissions.
<b>bandwidth</b>	Width of the range of frequencies supported by a given channel.
<b>bearer service</b>	Set of services offered over the B-channel (bearer channel) that enables the exchange of signals between two user-network interfaces.

---

<b>bridge</b>	A device that connects two or more physical networks and forwards packets between them. Bridges can usually be made to filter packets, that is, to forward only certain traffic.
<b>broadcast</b>	A packet delivery system where a copy of a given packet is given to all hosts attached to the network. Example: Ethernet.
<b>call control (cc)</b>	Equivalent to OSI Transport Layer.
<b>calling number</b>	The local phone number (your number) used in configuring connections.
<b>called number</b>	The remote phone number (destination number) in configuring connections.
<b>CCITT</b>	Consultative Committee for International Telegraph and Telephone. A committee concerned with recommendations concerning public telegraph, telephone, and data networks. Responsible for the definition of the ISDN protocols.
<b>central office (CO)</b>	The switching office maintained by the local ISDN carrier that provides access to the ISDN and its associated services.
<b>CCP</b>	Compression Control Protocol. Draft Internet standard for negotiating data compression over PPP link.
<b>CHAP</b>	Challenge Handshake Authentication Protocol. A security tool offered in PPP based on encrypted password exchange.
<b>circuit-switched network</b>	A network that operates by establishing a dedicated connection between two systems for the duration of a call. Examples: the public telephone network, ISDN.
<b>CLI</b>	Calling Line Identifier. Calling number used by the switch to ensure the integrity of the call and restrict access based upon the identifier. CLI is not supported by all ISDN carriers.
<b>client-server model</b>	A common way to describe network services and the model user processes (programs) of those services. Examples include the name-server/name-resolver paradigm of the DNS and file-server/file-client relationships such as NFS and diskless hosts.
<b>configuration file (cf)</b>	The file that ISDN looks at when setting up a call to determine which parameters are set for the originating terminal equipment.

---

<b>connectionless</b>	The model of interconnection in which communication takes place without first establishing a connection. Sometimes (imprecisely) called datagram. Examples: LANs, Internet IP and OSI CLNP, UDP, ordinary postcards.
<b>connection-oriented</b>	The model of interconnection in which communication proceeds through three well-defined phases: connection establishment, data transfer, connection release. Examples: ISDN, X.25, Internet TCP and OSI TP4, ordinary telephone calls.
<b>connection manager</b>	The component of the SunISDN software that controls and manages all incoming and outgoing calls. The connection manager is also responsible for enforcing the call acceptance policy used to protect the network from unauthorized access.
<b>custom</b>	In North America, AT&T and Northern Telecom switch software prior to standardized National ISDN (1 or 2).
<b>D channel</b>	ISDN out-of-band signalling channel. Carries user-network signalling information at a rate of 16 kbps (for BRI). Primarily used in call setup and tear down.
<b>data link layer (dl)</b>	The protocol layer responsible for the error-free transmission of information between directly connected systems. Normally used to describe the second layer of the OSI Reference Model. (Refer to OSI Layer 2).
<b>digital</b>	Discrete signals or data that can only have specified values within a predefined range. Example: binary data transmission.
<b>domain</b>	In the Internet, a part of a naming hierarchy. Syntactically, an Internet domain name consists of a sequence of names (labels) separated by periods (dots), e.g., <code>tundra.mpk.ca.us</code> .
<b>DN</b>	Directory number—telephone number for ISDN. Each BRI can have up to two directory numbers, one for each B channel.
<b>dot notation</b>	The syntactic representation for a 32-bit integer that consists of four 8-bit numbers written in base 10 with periods (dots) separating them. Used to represent IP addresses in the Internet as in: <code>192.67.67.20</code> .
<b>dynamic connection</b>	A connection that is opened and closed on demand.
<b>dynamic route</b>	A connection to a router set up automatically by a server when a call is set up and broken when the call is torn down.

---

<b>EAZ</b>	(EndgerateAuswahlZiffer [selection digit]) Deutsche Bundespost Telekom only. Used to differentiate between devices with the same ISDN number (1-9), 0 indicates voice broadcast. EAZ is specified in the <code>cc_local_nb</code> field.
<b>encapsulation</b>	The technique used by layered protocols in which a layer adds header information to the protocol data unit (PDU) from the layer above. As an example, in Internet terminology, a packet contains a header from the physical layer, followed by a header from the network layer (IP), followed by a header from the transport layer (TCP), followed by the application protocol data.
<b>fragmentation</b>	The process in which an IP datagram is broken into smaller pieces to fit the requirements of a given physical network. The reverse process is called <i>reassembly</i> .
<b>frame</b>	A unit of transmission (that is, a transmitted data packet). When the IP passes the Data Link layer, a datagram and the Data Link layer adds a header and trailer to the data package. The whole package is referred to as a <i>frame</i> .
<b>gateway</b>	The original Internet term for what is now called router or more precisely, IP router. In modern usage, the terms “gateway” and “application gateway” refer to systems which do translation from some native format to another. The SunISDN software subsystem can be used to turn a system into a gateway between the ISDN and an IP subnetwork.
<b>I.441</b>	See <i>Q.921</i> .
<b>I.451</b>	See <i>Q.931</i> .
<b>IP datagram</b>	The fundamental unit of information passed across the Internet. Contains source and destination addresses along with data and a number of fields which define such things as the length of the datagram, the header checksum, and flags to say whether the datagram can be (or has been) fragmented.
<b>IP</b>	Internet Protocol. The network layer protocol for the Internet protocol suite.
<b>IP/dialup interface</b>	A logical interface used to attach the IP network layer to a physical interface on demand—that is, when it is dialed up. May be point-to-point ( <code>ifppp&lt;num&gt;</code> ).
<b>IP point-to-point</b>	An IP configuration whereby exactly two systems are connected across a network.

---

<b>ISDN</b>	Integrated Services Digital Network. A collection of digital telephone and circuit-switched networks, interconnected by exchange systems and accessed through well-defined network interfaces that provide integrated access to the network. Having evolved directly from the public telephone systems, ISDN is closely associated with telephone technology.
<b>ISDN number</b>	The address assigned to an ISDN line. It is the equivalent of a standard telephone number and normally adheres to the local telephone numbering scheme.
<b>ISDN point-to-multipoint</b>	ISDN configuration whereby multiple ISDN-compatible devices are attached to a single ISDN line. Up to eight devices can be attached in an ISDN point-to-multipoint configuration. Also called ISDN multipoint configuration.
<b>ISDN point-to-point</b>	ISDN configuration whereby exactly one ISDN-compatible device is attached to a single ISDN line.
<b>ISDN reference configuration</b>	A configuration model that describes the user-network interface in terms of predefined functional devices and references points.
<b>ISO</b>	International Organization for Standardization. An international organization concerned with the definition of a wide range of standards including HDLC and the OSI protocols.
<b>Internet</b>	(note the capital "I") The largest internet in the world consisting of large national backbone nets (such as MILNET, NSFNET, and CREN) and a myriad of regional and local campus networks all over the world. The Internet uses the Internet protocol suite. To be on the Internet you must have IP connectivity, i.e., be able to Telnet to--or ping--other systems. Networks with only e-mail connectivity are not actually classified as being on the Internet.
<b>Internet address</b>	A 32-bit address assigned to hosts using TCP/IP. See <i>dotted decimal notation</i> .
<b>ifconfig</b>	The interface configuration command used to assign an address to a network interface or to define network interface parameters. Used within the context of SunISDN to control the IP/dialup interfaces used to attach the IP network layer to the physical interface for the duration of a call.
<b>internet</b>	A collection of networks interconnected by a set of routers that enable them to function as a single, large virtual network.
<b>LAN</b>	local-area network. A network interconnecting devices over a limited geographical area (typically less than 10 km). Ethernet is LAN technology.

---

<b>LCP</b>	Link control protocol. A subset of the PPP protocol used to establish, configure, and test data link connections.
<b>local numbers</b>	The phone number of the site being configured, that is, the calling number (not the remote site number). Also, this is a separate field that adds additional identification along with (or sometimes simply repeats) the calling number.
<b>local system</b>	The system on which the SunISDN software is installed and configured.
<b>MP</b>	Multilink Protocol is based on a LCP option that permits combining multiple physical links into a "bundle." The bundle provides a virtual link with greater bandwidth than any of the constituent members.
<b>multiplexing</b>	A procedure that enables multiple users to access a single facility. Common multiplexing schemes include time-division multiplexing and frequency-division multiplexing.
<b>NCP</b>	Network Control Program. A subset of the Point-to-Point Protocol used to establish and configure different network-layer protocols.
<b>network termination</b>	An ISDN-compatible device that provides the physical and electrical termination between a terminal equipment (TE) device and the ISDN exchange.
<b>network signaling (ns)</b>	This is equivalent to the OSI network layer.
<b>NT1</b>	Low-level (simple) network termination device that provides physical and electrical termination only.
<b>NT2</b>	High-level (complex) network termination device that performs multiplexing and message-handling functions in addition to simple physical and electrical termination.
<b>octet</b>	An alpha-numeric character.
<b>OSI</b>	Open Systems Interconnection. An international standard for interconnection based on a seven layer model. ISN follows the OSI standard. Layers 1 to 3 are referred to in ISDN as bearer service and the upper four layers are teleservices. The seven levels of interconnection are <ul style="list-style-type: none"> <li>• Layer 1 - Physical Layer <ul style="list-style-type: none"> <li>For example, the SunISDN SBus board and ISDN driver.</li> </ul> </li> </ul>



- 
- **Layer 2 - Data Link Layer**  
Concerned with the synchronization of data, flow control, and detection of transmission errors. PPP is a data link protocol.
  - **Layer 3 - Network Layer**  
Concerned with routing and network connections. IP is the network layer protocol.
  - **Layer 4 - Transport Layer**  
Provides an interface between the upper teleservices layers and the bearer layers. Designed to give the user certain network options, but generally separate them from the lower level functional aspects. TCP and UTP are transport layer technologies.
  - **Layer 5 - Session Layer**  
User interface into the transport layer. Not part of typical ISDN implementations.
  - **Layer 6 - Presentation Layer**  
Provides syntax for the representation of data. Not part of typical ISDN implementations.
  - **Layer 7 - Application Layer**  
End user applications.

<b>packet</b>	A transmission unit that consists of a protocol header plus data.
<b>PAP</b>	Password Authentication Protocol. One of the security provisions available in PPP. (See <i>PP authentication</i> .)
<b>PAP-Token-CHAP</b>	Authentication scheme that combines both PAP and CHAP authentication along with a security card to provide a greater degree of security than PAP or CHAP.
<b>PPP</b>	Point-to-Point Protocol. PPP provides router-to-router and host-to-network connections over both synchronous and asynchronous circuits. It is used within the context of SunISDN to provide a direct link between the IP network layers on two systems.
<b>PPP authentication</b>	An optional phase of the PPP negotiation process that is used to determine the source of an incoming call based on the verification of an identifier-password pair. Used by SunISDN as part of its global call acceptance policy.
<b>ping</b>	Packet internet groper. A program used to test reachability of destinations by sending them an ICMP echo request and waiting for a reply.

---

<b>phone company/provider</b>	Information necessary to configure your system is obtained from the local phone company. Networking information is obtained from an internet provider. The network internet provider provides much of the remote site information.
<b>physical interface</b>	The means by which a system running SunISDN is attached to the network. It consists of the hardware interface, the connection to the local exchange, and the associated configuration elements.
<b>physical layer</b>	The protocol layer responsible for the physical and electrical transmission of information between directly connected systems. Normally used to describe Layer 1 of the OSI reference model.
<b>pkgadd, pkgrm, pkginfo</b>	Solaris provides a utility to install groups of related files. These commands are used to load (add), remove (rm) and get information (info) about packages that are installed on your system. A typical package for Sun would have the prefix SUNW.
<b>POTS</b>	Plain Old Telephone Service (analog).
<b>PRI</b>	Primary Rate Interface. A standard, similar to BRI (Basic Rate Interface), defined by the CCITT protocol, but provides multiple B channels (23 or 30) that are supported by a single D channel.
<b>protocol</b>	A formal description of messages to be exchanged and rules to be followed for two or more systems to exchange information.
<b>protocol reference point</b>	See <i>reference point</i> .
<b>PTP</b>	Point-to-Point Protocol. A connection between only two systems.
<b>Q.921</b>	CCITT recommendation that describes the Link Access Procedure, D-channel (LAP-D) used to transfer network layer messages across the D-channel. It defines layer 2 of the D-channel protocol.
<b>Q.931</b>	CCITT recommendation describing the procedures for establishing, maintaining, and closing connections across the ISDN. It defines layer 3 of the D-channel protocol.
<b>R reference point</b>	Part of the ISDN reference configuration. A protocol reference point that exists between a non-ISDN device (TE2) and a terminal adapter (TA). The protocols that define this transmission line are defined by the manufacturer of the terminal adapter.

---

<b>reference point</b>	Part of the ISDN reference configuration. A conceptual protocol interface that exists between two types of ISDN device. See also R, S, T, U, and V reference points.
<b>reference configuration</b>	See <i>ISDN reference configuration</i> .
<b>RFC 1717</b>	PPP Multilink Protocol (MP) Internet standard for splitting, recombining, and sequencing datagrams across multiple logical data links.
<b>rlogin</b>	A UNIX command that enables users of one machine to log into other UNIX systems (for which they are authorized) and interact as if their terminals were connected directly. Similar to Telnet.
<b>router</b>	A machine that performs a relaying function between networks. Also known as a <i>gateway</i> .
<b>S reference point</b>	Part of the ISDN reference configuration. A protocol reference point that exists between terminal equipment (TE) devices and network termination (NT) devices. The protocols that define this transmission line are defined by the CCITT.
<b>segment</b>	When the transport layer protocol, TCP, adds an information header to a packet of data for decoding by TCP on the remote machine, the expanded packet is referred to as a segment. It is then passed to the network layer that converts it to a datagram. It then goes to the data link layer which converts it to a frame.
<b>SMTP</b>	Simple Mail Transfer Protocol. The Internet electronic mail protocol. Defined in RFC 821, with associated message format descriptions in RFC 822.
<b>SPID</b>	Service Profile IDentifier. Used in North America as an additional identifier, in conjunction with the calling number ( <i>cc_calling_nb</i> ), to identify the local number to the local switch.
<b>static connection</b>	A connection that is opened once and remains open. Equivalent to a leased-line arrangement.
<b>static route</b>	A fixed address to a remote router that does not disappear when the link is torn down.
<b>subaddress</b>	Additional address that is used to identify a specific device at a specific ISDN interface (for example, in an ISDN multipoint configuration). Subaddresses identify the device only and do not identify the ISDN interface. They are not used for routing across the network.

---

<b>subnet mask</b>	See <i>address mask</i> .
<b>subnetwork</b>	A collection of network end systems and intermediate systems under the control of a single administrative domain and utilizing a single network access protocol. Examples: private X.25 networks, collection of bridged LANs.
<b>synchronous</b>	Timed operation that is usually controlled through a synchronizing clock. Often used to refer to any time-sensitive application.
<b>supplementary services</b>	Value-added services offered by the ISDN or another ISDN subscriber that provide facilities in addition to communication between end-users. Examples: conference call facility, call transfer, call hold.
<b>switching</b>	The procedure used to connect two devices in a network.
<b>T reference point</b>	Part of the ISDN reference configuration. A protocol reference point that exists between NT1 and NT2 devices. The protocols that define this transmission line are defined by the CCITT.
<b>TCP/IP</b>	Transmission Control Protocol/Internet Protocol. The major transport protocol in the Internet suite of protocols providing reliable, connection-oriented, full-duplex streams. Uses IP for delivery. TCP/IP is the standard protocol for the internet.
<b>telecommunication</b>	The transmission of signals representing voice, video, or data.
<b>teleservices</b>	Value-added services offered by the ISDN or another ISDN subscriber that provide communication between end-users.
<b>Telnet</b>	The virtual terminal protocol in the Internet suite of protocols. Allows users of one host to log into a remote host and interact as normal terminal users of that host.
<b>terminal adapter (TA)</b>	ISDN-compatible device that converts non-ISDN transmission to ISDN transmission.
<b>terminal equipment (TE)</b>	ISDN-compatible terminal device that is attached to the ISDN at the user interface. Example: ISDN-compatible telephone, system running SunISDN.
<b>TE1</b>	ISDN-compatible terminal equipment. Can be connected directly to a network termination (NT) device.
<b>TE2</b>	Non-ISDN terminal equipment. Can be connected to a network termination (NT) device through a terminal adapter (TA).

---

<b>time division multiplexing</b>	A multiplexing scheme whereby several users are assigned specific portions of the bandwidth of a transmission medium by time.
<b>U reference point</b>	Part of the ISDN reference configuration. A protocol reference point that exists between NT1 devices and the ISDN exchange. The protocols that define this transmission line are not defined by the CCITT.
<b>UDP</b>	User Datagram Protocol. A transport protocol in the Internet suite of protocols. UDP, like TCP, uses IP for delivery; however, unlike TCP, UDP provides for exchange of datagrams without acknowledgments or guaranteed delivery.
<b>UUCP</b>	UNIX to UNIX Copy Program. A protocol used for communication between consenting UNIX systems.
<b>VJ</b>	Van Jacobson algorithm for IP header compression. Compresses the IP header to three bytes.
<b>V reference point</b>	Part of the ISDN reference configuration. A protocol reference point that exists between the ISDN exchange and the rest of the network. The protocols that define this transmission line are not defined by the CCITT.
<b>WAN</b>	wide area network. A network interconnecting devices over a large geographical area (typically greater than 10 km). ISDN is WAN technology.



# *Index*

---

## **A**

asynchronous PPP, 20, 98  
AT&T 5ESS 5e5, 80

## **B**

Bandwidth Controller, 46  
bandwidth\_controller, 11  
B-channel  
    baud rate, 95  
binary data, 74, 77

## **C**

call  
    acceptance policy, 13  
CCITT  
    compliant networks, 99

## **D**

data  
    link layer, 74  
D-channel  
    isdntrace, 74  
    isdntrace example, 80  
decoded data, 74  
default\_route, 97

## **E**

Enigma DES Gold Card, 14  
ETSI, 99  
example traces, 81

## **I**

icmp echo  
    request, 95  
    response, 95  
information element (IE), 79  
input device, 75  
IP  
    routing, 94, 97  
IP/dialup  
    point-to-point, 9, 10  
ISDN2, 99  
isdnmgr.log, 94  
isdntrace, 74, 75  
    example, 80  
ISN-Net64, 99

## **J**

journal file, 94

---

## L

lost data indication, 80, 90

## M

multipoint  
IP/dialup configuration, 10

## N

negotiate\_address, 97  
negotiation process, 13  
netstat(1M), 94  
network  
layer, 74

## O

output from isdntrace, 80

## P

PAP-Token-CHAP, 14  
physical  
interface, 75  
layer, 74  
ping(1M), 94  
point-to-multipoint  
IP/dialup configuration, 10  
point-to-point  
IP/dialup configuration, 9  
PPP password authentication  
PPP identifier, 13  
PPP password, 13  
protocol, 13  
ppptrace, 93  
problems  
calling a remote system, 94  
communicating with a remote  
system, 95

## R

remote system, 94

route(1M), 94  
routing, 94, 97

## S

security card, 14  
snoop(1M), 95  
solving problems  
calling a remote system, 94  
communicating with a remote  
system, 95

## T

TCP/IP, 13, 97  
time stamping, 79, 89



## Reader Comment Card

Your comments and suggestions are important to us. Please let us know what you think about the *SunISDN 1.0.4 User's Guide*, part number 802-6280-11.

1. Were the procedures well documented? Yes  No

Please explain: \_\_\_\_\_  
\_\_\_\_\_

2. Were the tasks easy to follow? Yes  No

Please explain: \_\_\_\_\_  
\_\_\_\_\_

3. Were the illustrations clear? Yes  No

Please explain: \_\_\_\_\_  
\_\_\_\_\_

4. Was the information complete and easy to find? Yes  No

Please explain: \_\_\_\_\_  
\_\_\_\_\_

5. Do you have additional comments about the *SunISDN 1.0.4 User's Guide*?

You can send detailed comments via email to [smcc-docs@sun.com](mailto:smcc-docs@sun.com), or send a fax to *SMCC Doc Feedback* at (415) 786-6443.

\_\_\_\_\_  
\_\_\_\_\_  
\_\_\_\_\_  
\_\_\_\_\_  
\_\_\_\_\_  
\_\_\_\_\_  
\_\_\_\_\_

Your Name: \_\_\_\_\_

Title: \_\_\_\_\_

Company Name: \_\_\_\_\_

Address: \_\_\_\_\_

City: \_\_\_\_\_ State/Province: \_\_\_\_\_

Country: \_\_\_\_\_ Zip/Postal Code: \_\_\_\_\_

Email Address: \_\_\_\_\_

Telephone: \_\_\_\_\_

Thank you.

**AIR MAIL  
PAR AVION**

IBRS/CCRI No. 808



**INTERNATIONAL BUSINESS REPLY MAIL/REPOSE PAYEE**

PERMIT NO. 808 MOUNTAIN VIEW CA

POSTAGE WILL BE PAID BY ADDRESSEE

INFORMATION PRODUCTS  
M/S MPK14-108  
SUN MICROSYSTEMS INC  
2550 GARCIA AVE  
MOUNTAIN VIEW CA 94043-9551  
UNITED STATES OF AMERICA

NE PAS AFFRANCHIR

NO POSTAGE  
NECESSARY  
IF MAILED  
TO THE  
UNITED STATES

